

---

# MS PLUS

---

VHM-SCHAFTFRÄSER SERIE

---

B205D



**NEW**

# MP3C

## FASFRÄSER, 3-SCHNEIDIG

Sehr gute Werkzeugstandzeit bei einer hocheffizienten Fasbearbeitung.

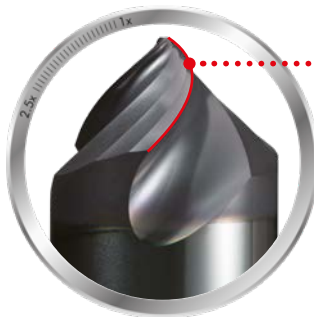

### **GESCHWUNGENE SCHNEIDKANTE**

Die geschwungene Schneidkante und der optimale Spiralwinkel bieten eine gute Schärfe und verhindern das Auftreten von Graten deutlich.

Der Faswinkel beträgt 45°.

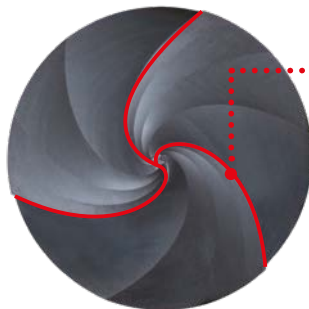

### **KONZEPT DES 3-SCHNEIDIGEN VHM-FASFRÄSERS**

Bearbeitung mit hohem Tischvorschub und einem hervorragenden Verhältnis zwischen vielseitiger Bearbeitung unterschiedlichster Materialien und sehr guter Spanabfuhr durch die Auslegung eines 3-schneidigen Werkzeugkonzeptes. Dies ermöglicht eine hocheffiziente Bearbeitung.

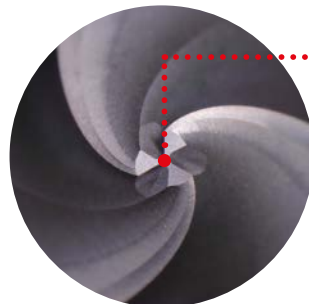

### **BEARBEITUNGSMÖGLICHKEITEN**

Der Fräsertyp kann neben Fas- und Entgratanwendungen auch für die V-Nuten-Bearbeitung verwendet werden.



V-Nuten-Bearbeitung

# MP3C

## HOCHEFFEKTIV FÜR DIE FASBEARBEITUNG

Die 3-schneidige Geometrie ermöglicht einen hohen Tischvorschub oder auch eine längere Werkzeugstandzeit. Die geschwungene Schneidkante verhindert deutlich die Bildung von Graten bei der Fasbearbeitung.

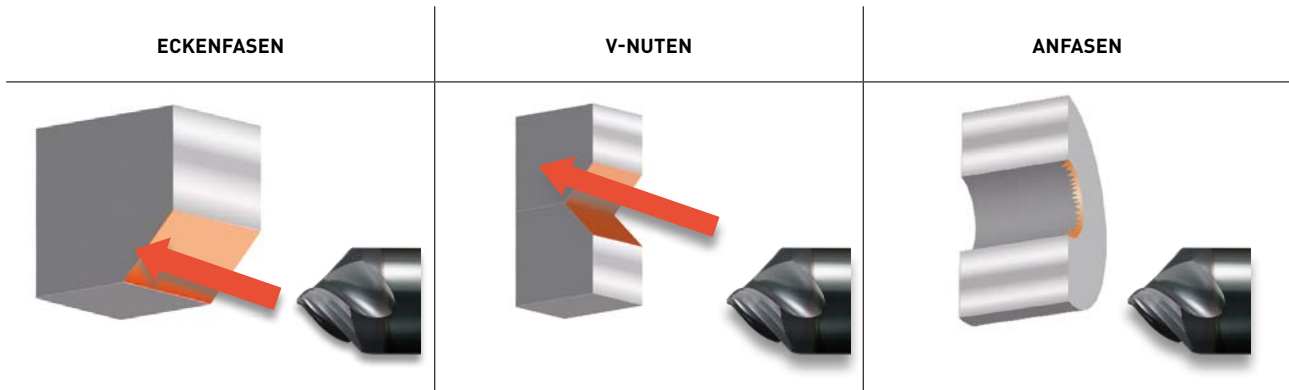

1. DLE und GKCD werden für die Zentrierung empfohlen.

Werkstoff	C55E (1.1203)
Werkzeug (mm)	DC = Ø 6
Vc (m/min)	100
n (min <sup>-1</sup> )	5300
fz (mm/Zahn)	0.03
ap (mm)	1.2
Länge der Auskragung (mm)	18
Schnittmodus	Druckluft

### VERGLEICH DER ERGEBNISSE NACH DER FASANWENDUNG BEI DER BEARBEITUNG VON C55E

<p><b>MP3C</b> 3-schneidig, geschwungene Schneidkante</p>		<p>Gute Oberflächenergebnis, Gratfrei</p>
<p>Herkömmlicher Fräser 4-schneidig, gerade Schneidkanten</p>		<p>Gratbildung</p>
<p>Herkömmlicher Fräser 2-schneidig, gerade Schneidkanten</p>		<p>Gratbildung</p>

# MS PLUS

## HARTMETALLSCHAFTFRÄSER-SERIE FÜR ALLGEMEINE BEARBEITUNG



### MULTILAYER-BESCHICHTUNG (Al,Ti,Cr)N (MS PLUS)

Eigens entwickelte Beschichtungstechnologie ermöglicht die PVD-Mehrlagenbeschichtung aus (Al,Ti)N und (Al,Cr)N die Bearbeitung von unterschiedlichen Materialien.

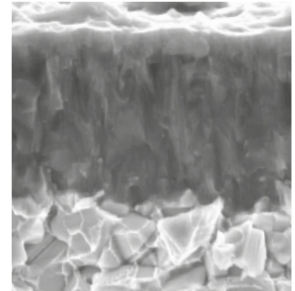

### EIGENSCHAFTEN DER MULTILAYER-BESCHICHTUNG (Al,Ti,Cr)N (MS PLUS)

	(Al,Ti,Cr)N Multilayer	(Al,Ti)N	(Al,Cr)N
Härte (Hv)	3200	2800	3100
Oxidationstemperatur (r)	1100	800	1100
Adhäsion (N)	100	80	80

## ANWENDUNGSBEREICH

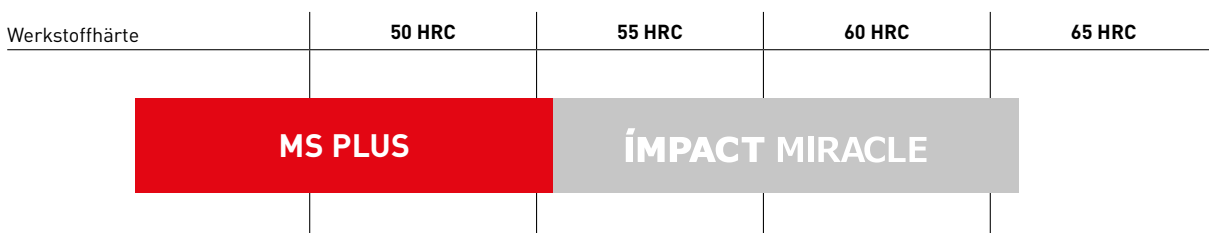

**MS PLUS BIETET EINE LANGE WERKZEUGSTANDZEIT BEI MATERIALIEN BIS ZU 55 HRC.**









Für Stahlsorten härter als 55 HRC werden IMPACT-MIRACLE-Fräser empfohlen.



# MS PLUS

## ANWENDUNGSBEREICH

Produkt- bezeichnung	Form		DC	P	M	S	N	H	
<b>ECKRADIUSFRÄSER</b>									
<b>MPMHVRB</b>	Eckradius, mittlere Schneidenlänge, 4-schneidig, variabler Drall		DC 1 - 20	☉	☉	○		○	7
<b>MPXLRB</b>	Eckradius, kurze Schnittlänge, langer Hinterschliff		DC 0,2 - 6	☉	○	○	○	☉	12
<b>SCHAFTFRÄSER</b>									
<b>MP2ES</b>	Schaftfräser, 2 Schneiden, für Langdrehautomaten, Mehrspindelautomaten und Drehautomaten		DC 3 - 10	☉	○	○	○	○	19
<b>MP3ES</b>	Schaftfräser, 3 Schneiden, für Langdrehautomaten, Mehrspindelautomaten und Drehautomaten		DC 3 - 12	☉	○	○	○	○	22
<b>MP4EC</b>	Schaftfräser, 4 Schneiden, für Langdrehautomaten, Mehrspindelautomaten und Drehautomaten		DC 3 - 14	☉	○	○	○	○	26
<b>MPSHV/W</b>	Schaftfräser, kurze Schneidenlänge, 2,5 × DC Hinterschliff, 4-schneidiger variabler Spiralwinkel		DC 6 - 20	☉	☉	○		○	30
<b>MPMHV/W</b>	Schaftfräser, mittlere Schnittlänge, 2,5 × DC Hinterschliff, 4-schneidiger variabler Spiralwinkel		DC 6 - 20	☉	☉	○		○	34
<b>MPMHV</b>	Schaftfräser, mittlere Schneidenlänge, 4-schneidig, variabler Spiralwinkel		DC 1 - 22	☉	☉	○		○	38
<b>MPJHV</b>	Schaftfräser, mittlere Schneidenlänge, 4-schneidig, variabler Spiralwinkel		DC 1 - 20	☉	☉	○		○	44

Produkt bezeichnung	Form		RE	P	M	S	N	H	
<b>KUGELKOPFFRÄSER</b>									
MP2SSB	Kugelkopffräser, kurze Schneidenlänge, 2-schneidig, kurzer Schaft		RE 0.1 - 6	⊙	○	○	○	⊙	47
MP2SB	Kugelkopffräser, kurze Schneidenlänge, 2-schneidig		RE 0.1 - 6	⊙	○	○	○	⊙	50
MP2MB	Kugelkopffräser, mittlere Schneidenlänge, 2-schneidig		RE 0.25 - 6	⊙	○	○	○	⊙	53
MP2SDB	Kugelkopffräser, kurze Schneidenlänge, 2-schneidig, hochstabil		RE 0.5 - 6	⊙				⊙	56
MP2XLB	Kugelkopffräser, 2-schneidig, langer Hinterschliff		RE 0.05 - 3	⊙			○	⊙	59
MP3XB	Kugelkopffräser, 3-schneidig, konischer Hinterschliff		RE 0.5 - 6	⊙			○	⊙	74
<b>FASFRÄSER</b>									
<b>NEW</b> MP3C	Fasfräser, 3-schneidig		RE 2 - 12	⊙	○	○		⊙	87

# MPMHVRB



## ECKRADIUS, MITTLERE SCHNEIDENLÄNGE, 4-SCHNEIDIG, VARIABLEL DRALL

P M S H

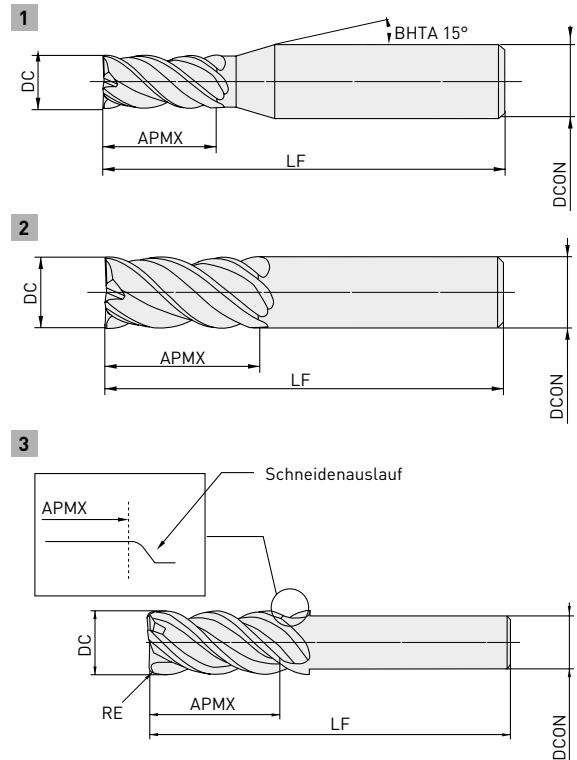

	0.1 ≤ RE ≤ 5				
	±0.015				
	DC ≤ 12	DC > 12			
	0	0			
	-0.02	-0.03			
	DCON = 4	DCON = 6	DCON = 8		
	0	0	0		
	-0.005	-0.005	-0.006		
	DCON = 8(DC=10)	DCON = 10(DC=12)	DCON = 10	12 ≤ DCON ≤ 16	DCON = 20
	0	0	0	0	0
	-0.009	-0.009	-0.009	-0.011	-0.013

- 4-schneidiger Schaftfräser mit variablem Spiralwinkel zur Vibrationskontrolle bei der Bearbeitung rostfreier Stähle und C-Stähle.

Bestellnummer	Lager	DC	RE	APMX	LF	DCON	ZEFP	Typ
MPMHVRBD0100R010	●	1	0.1	2.5	45	4	4	1
MPMHVRBD0100R020	●	1	0.2	2.5	45	4	4	1
MPMHVRBD0200R010	●	2	0.1	5	45	4	4	1
MPMHVRBD0200R020	●	2	0.2	5	45	4	4	1
MPMHVRBD0200R030	●	2	0.3	5	45	4	4	1
MPMHVRBD0200R050	●	2	0.5	5	45	4	4	1
MPMHVRBD0300R010	●	3	0.1	7.5	45	6	4	1
MPMHVRBD0300R020	●	3	0.2	7.5	45	6	4	1
MPMHVRBD0300R030	●	3	0.3	7.5	45	6	4	1
MPMHVRBD0300R050	●	3	0.5	7.5	45	6	4	1
MPMHVRBD0400R010	●	4	0.1	10	45	6	4	1
MPMHVRBD0400R020	●	4	0.2	10	45	6	4	1
MPMHVRBD0400R030	●	4	0.3	10	45	6	4	1
MPMHVRBD0400R050	●	4	0.5	10	45	6	4	1
MPMHVRBD0400R100	●	4	1	10	45	6	4	1

● : Lagerstandard. ★ : Lagerstandard in Japan.

# MPMHVRB

Bestellnummer		DC	RE	APMX	LF	DCON	ZEFP	Typ
MPMHVRBD0500R010	●	5	0.1	12.5	50	6	4	1
MPMHVRBD0500R020	●	5	0.2	12.5	50	6	4	1
MPMHVRBD0500R030	●	5	0.3	12.5	50	6	4	1
MPMHVRBD0500R050	●	5	0.5	12.5	50	6	4	1
MPMHVRBD0500R100	●	5	1	12.5	50	6	4	1
MPMHVRBD0600R010	●	6	0.1	15	60	6	4	2
MPMHVRBD0600R020	●	6	0.2	15	60	6	4	2
MPMHVRBD0600R030	●	6	0.3	15	60	6	4	2
MPMHVRBD0600R050	●	6	0.5	15	60	6	4	2
MPMHVRBD0600R100	●	6	1	15	60	6	4	2
MPMHVRBD0800R020	●	8	0.2	20	70	8	4	2
MPMHVRBD0800R030	●	8	0.3	20	70	8	4	2
MPMHVRBD0800R050	●	8	0.5	20	70	8	4	2
MPMHVRBD0800R100	●	8	1	20	70	8	4	2
MPMHVRBD0800R150	●	8	1.5	20	70	8	4	2
MPMHVRBD0800R200	●	8	2	20	70	8	4	2
MPMHVRBD0800R250	●	8	2.5	20	70	8	4	2
MPMHVRBD0800R300	●	8	3	20	70	8	4	2
MPMHVRBD1000R030S08	●	10	0.3	25	100	8	4	3
MPMHVRBD1000R050S08	●	10	0.5	25	100	8	4	3
MPMHVRBD1000R100S08	●	10	1	25	100	8	4	3
MPMHVRBD1000R200S08	●	10	2	25	100	8	4	3
MPMHVRBD1000R020	●	10	0.2	25	80	10	4	2
MPMHVRBD1000R030	●	10	0.3	25	80	10	4	2
MPMHVRBD1000R050	●	10	0.5	25	80	10	4	2
MPMHVRBD1000R100	●	10	1	25	80	10	4	2
MPMHVRBD1000R150	●	10	1.5	25	80	10	4	2
MPMHVRBD1000R200	●	10	2	25	80	10	4	2
MPMHVRBD1000R250	●	10	2.5	25	80	10	4	2
MPMHVRBD1000R300	●	10	3	25	80	10	4	2
MPMHVRBD1200R030S10	●	12	0.3	30	110	10	4	3
MPMHVRBD1200R050S10	●	12	0.5	30	110	10	4	3
MPMHVRBD1200R100S10	●	12	1	30	110	10	4	3
MPMHVRBD1200R200S10	●	12	2	30	110	10	4	3
MPMHVRBD1200R300S10	●	12	3	30	110	10	4	3
MPMHVRBD1200R030	●	12	0.3	30	100	12	4	2
MPMHVRBD1200R050	●	12	0.5	30	100	12	4	2
MPMHVRBD1200R100	●	12	1	30	100	12	4	2
MPMHVRBD1200R150	●	12	1.5	30	100	12	4	2
MPMHVRBD1200R200	●	12	2	30	100	12	4	2
MPMHVRBD1200R300	●	12	3	30	100	12	4	2
MPMHVRBD1600R030	●	16	0.3	40	110	16	4	2
MPMHVRBD1600R050	●	16	0.5	40	110	16	4	2
MPMHVRBD1600R100	●	16	1	40	110	16	4	2
MPMHVRBD1600R200	●	16	2	40	110	16	4	2
MPMHVRBD1600R300	●	16	3	40	110	16	4	2
MPMHVRBD1600R500	●	16	5	40	110	16	4	2
MPMHVRBD2000R030	●	20	0.3	50	125	20	4	2
MPMHVRBD2000R050	●	20	0.5	50	125	20	4	2
MPMHVRBD2000R100	●	20	1	50	125	20	4	2
MPMHVRBD2000R200	●	20	2	50	125	20	4	2
MPMHVRBD2000R300	●	20	3	50	125	20	4	2
MPMHVRBD2000R500	●	20	5	50	125	20	4	2

# MPMHVRB

## SCHNITTDATENEMPFEHLUNGEN

### SCHULTERFRÄSEN

Material	DC	n	Vf	ap	ae
C-Stahl, legierter Stahl, duktileres Gusseisen	1	38000	910	1.7	0.2
	1.5	27000	970	2.5	0.3
	2	21000	1500	3.5	0.4
	2.5	18000	1700	4.2	0.5
	3	16000	1800	5	0.6
	4	12000	1700	7	0.8
	5	9500	1800	8.5	1
	6	8000	2100	10	1.2
	7	6800	2000	12	1.4
	8	6000	2000	13.5	1.6
	10	4800	2100	17	2
	11	2600	1200	18.5	1.1
	12	4000	1900	20.5	2.4
	13	2200	1100	22	1.3
	16	3000	1400	27.2	3.2
20	2400	1200	34	4	
C-Stahl, legierter Stahl, vergüteter Stahl, legierter Werkzeugstahl	1	31000	500	1.7	0.2
	1.5	22000	530	2.5	0.3
	2	17000	820	3.5	0.4
	2.5	15000	900	4.2	0.5
	3	13000	940	5	0.6
	4	9500	950	7	0.8
	5	7600	1100	8.5	1
	6	6400	1300	10	1.2
	7	5500	1400	12	1.4
	8	4800	1400	13.5	1.6
	10	3800	1500	17	2
	11	2100	880	18.5	1.1
	12	3200	1400	20.5	2.4
	13	1800	830	22	1.3
	16	2400	1100	27.2	3.2
20	1900	840	34	4	
Austenitische rostfreie Stähle, Titanlegierungen	1	25000	500	1.7	0.2
	1.5	18000	500	2.5	0.3
	2	14000	640	3.5	0.4
	2.5	12000	820	4.2	0.5
	3	11000	880	5	0.6
	4	8000	900	7	0.8
	5	6400	900	8.5	1
	6	5300	1100	10	1.2
	7	4500	1200	12	1.4
	8	4000	1200	13.5	1.6
	10	3200	1100	17	2
	11	1700	520	18.5	1.1
	12	2700	1100	20.5	2.4
	13	1500	490	22	1.3
	16	2000	840	27.2	3.2
20	1600	670	34	4	

# MPMHVRB

## SCHULTERFRÄSEN

Material	DC	n	Vf	ap	ae
H Gehärteter Stahl (45 - 55 HRC)	1	18000	290	1.7	0.05
	1.5	13000	310	2.5	0.08
	2	10000	320	3.5	0.1
	2.5	8500	360	4.2	0.13
	3	7400	380	5	0.15
	4	5600	400	7	0.2
	5	4500	430	8.5	0.25
	6	3700	440	10	0.3
	7	3200	450	12	0.35
	8	2800	450	13.5	0.4
	10	2200	440	17	0.5
	11	1200	190	18.5	0.55
	12	1900	380	20.5	0.6
	13	1000	160	22	0.65
	16	1400	340	27.2	0.8
	20	1100	260	34	1



## NUTENFRÄSEN

Material	DC	n	Vf	ap
P C-Stahl, legierter Stahl, duktiles Gusseisen	1	31000	620	0.5
	1.5	22000	630	0.8
	2	17000	650	2
	2.5	15000	830	2.5
	3	13000	940	3
	4	9500	820	4
	5	7600	910	5
	6	6400	860	6
	7	5500	960	7
	8	4800	1000	8
	10	3800	910	10
	12	3200	920	12
	16	2400	690	16
	20	1900	550	20

# MPMHVRB

## NUTENFRÄSEN

Material	DC	n	Vf	ap
P C-Stahl, legierter Stahl, vergüteter Stahl, legierter Werkzeugstahl	1	24000	380	0.5
	1.5	17000	410	0.8
	2	14000	450	2
	2.5	12000	580	2.5
	3	10000	660	3
	4	7600	600	4
	5	6100	670	5
	6	5100	630	6
	7	4400	710	7
	8	3800	750	8
	10	3100	680	10
	12	2500	660	12
	16	1900	500	16
20	1500	400	20	
M Austenitische rostfreie Stähle, Titanlegierungen	1	20000	400	0.5
	1.5	14000	390	0.8
	2	11000	500	2
	2.5	9700	660	2.5
	3	8500	680	3
	4	6400	720	4
	5	5100	710	5
	6	4200	870	6
	7	3600	940	7
	8	3200	960	8
	10	2500	880	10
	12	2100	860	12
	16	1600	380	16
20	1300	310	20	
S H Gehärteter Stahl (45 – 55 HRC)	1	9500	110	0.2
	1.5	6400	130	0.3
	2	4800	130	0.4
	2.5	3800	130	0.5
	3	3200	140	0.6
	4	2400	150	0.8
	5	1900	170	1
	6	1600	190	1.2
	7	1400	190	1.4
	8	1200	190	1.6
	10	950	150	2
	12	800	160	2.4
	16	600	120	3.2
20	480	96	4	

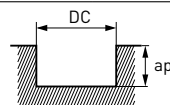



# MPXLRB

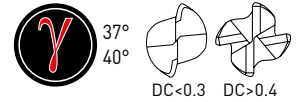

## ECKRADIUS, KURZE SCHNITTLÄNGE, LANGER HINTERSCHLIFF

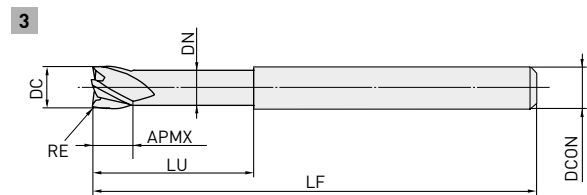
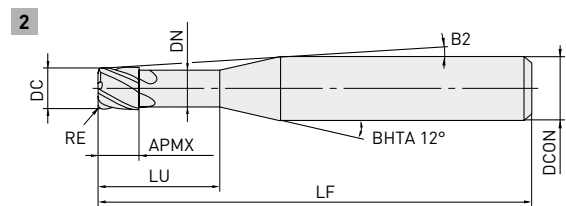
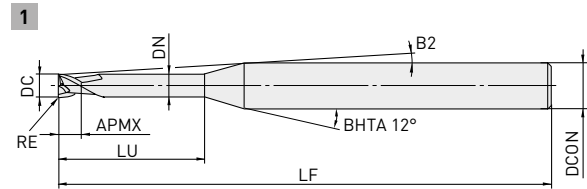

	$0.1 \leq RE \leq 5$
	$\pm 0.005$
	$DC \leq 6$
	0 -0.01
	$DCON \leq 6$
	0 -0.005

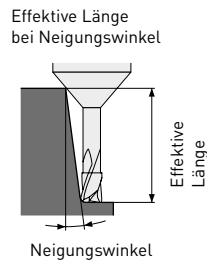

- 2 bzw. 4-schneidiger Eckradienfräser mit Vibrationskontrolle, für die Bearbeitung von Kohlenstoffstählen bis hin zu rostfreien Stählen.

Bestellnummer	Lager	DC	RE	APMX	LU	DN	B2	LF	DCON	ZEFP	Typ	Effektive Länge bei Neigungswinkel			
												30°	1°	2°	3°
MPXLRBD0020R005N005	●	0.2	0.05	0.2	0.5	0.18	11.4°	50	4	2	1	0.5	0.5	0.6	0.7
MPXLRBD0020R005N010	●	0.2	0.05	0.2	1	0.18	10.8°	50	4	2	1	1.0	1.1	1.2	1.3
MPXLRBD0030R005N010	●	0.3	0.05	0.3	1	0.28	10.8°	50	4	2	1	1.0	1.1	1.2	1.3
MPXLRBD0030R005N020	●	0.3	0.05	0.3	2	0.28	9.8°	50	4	2	1	2.1	2.2	2.4	2.7
MPXLRBD0040R005N020	●	0.4	0.05	0.4	2	0.37	9.8°	50	4	4	2	2.1	2.2	2.4	2.6
MPXLRBD0040R005N030	●	0.4	0.05	0.4	3	0.37	8.9°	50	4	4	2	3.1	3.3	3.6	4.0
MPXLRBD0040R005N040	●	0.4	0.05	0.4	4	0.37	8.2°	50	4	4	2	4.2	4.3	4.8	5.3
MPXLRBD0050R005N020	●	0.5	0.05	0.5	2	0.47	9.7°	50	4	4	2	2.1	2.2	2.4	2.6
MPXLRBD0050R005N030	●	0.5	0.05	0.5	3	0.47	8.9°	50	4	4	2	3.1	3.3	3.6	4.0
MPXLRBD0050R005N040	●	0.5	0.05	0.5	4	0.47	8.1°	50	4	4	2	4.2	4.3	4.8	5.3
MPXLRBD0050R005N050	●	0.5	0.05	0.5	5	0.47	7.5°	50	4	4	2	5.2	5.4	6.0	6.6
MPXLRBD0060R005N020	●	0.6	0.05	0.6	2	0.57	9.7°	50	4	4	2	2.1	2.2	2.4	2.6
MPXLRBD0060R005N040	●	0.6	0.05	0.6	4	0.57	8.1°	50	4	4	2	4.2	4.3	4.8	5.3
MPXLRBD0060R005N060	●	0.6	0.05	0.6	6	0.57	6.9°	50	4	4	2	6.2	6.5	7.2	7.9
MPXLRBD0080R005N040	●	0.8	0.05	0.8	4	0.77	7.9°	50	4	4	2	4.2	4.3	4.8	5.3
MPXLRBD0080R005N060	●	0.8	0.05	0.8	6	0.77	6.8°	50	4	4	2	6.2	6.5	7.2	7.9
MPXLRBD0100R005N030	●	1	0.05	1	3	0.96	8.3°	50	4	4	2	3.2	3.4	3.8	4.2
MPXLRBD0100R005N040	●	1	0.05	1	4	0.96	7.6°	50	4	4	2	4.3	4.5	5.0	5.6
MPXLRBD0100R005N050	●	1	0.05	1	5	0.96	7.0°	50	4	4	2	5.4	5.6	6.2	6.9
MPXLRBD0100R005N060	●	1	0.05	1	6	0.96	6.5°	50	4	4	2	6.4	6.7	7.4	8.2
MPXLRBD0100R005N080	●	1	0.05	1	8	0.96	5.6°	50	4	4	2	8.5	8.9	9.8	10.9

# MPXLRB

Bestellnummer	Lager	DC	RE	APMX	LU	DN	B2	LF	DCON	ZEFP	Typ	Effektive Länge bei Neigungswinkel			
												30°	1°	2°	3°
												MPXLRBD0100R005N100	●	1	0.05
MPXLRBD0100R005N120	●	1	0.05	1	12	0.96	4.5°	50	4	4	2	12.7	13.3	14.6	16.2
MPXLRBD0100R010N030	●	1	0.1	1	3	0.96	8.4°	50	4	4	2	3.2	3.4	3.8	4.2
MPXLRBD0100R010N040	●	1	0.1	1	4	0.96	7.6°	50	4	4	2	4.3	4.5	5.0	5.5
MPXLRBD0100R010N050	●	1	0.1	1	5	0.96	7.0°	50	4	4	2	5.3	5.6	6.2	6.9
MPXLRBD0100R010N060	●	1	0.1	1	6	0.96	6.5°	50	4	4	2	6.4	6.7	7.4	8.2
MPXLRBD0100R010N080	●	1	0.1	1	8	0.96	5.6°	50	4	4	2	8.5	8.9	9.8	10.8
MPXLRBD0100R010N100	●	1	0.1	1	10	0.96	5.0°	50	4	4	2	10.6	11.1	12.2	13.5
MPXLRBD0100R010N120	●	1	0.1	1	12	0.96	4.5°	50	4	4	2	12.7	13.3	14.6	16.2
MPXLRBD0120R010N100	●	1.2	0.1	1.2	10	1.16	4.8°	50	4	4	2	10.6	11.1	12.2	13.5
MPXLRBD0120R020N100	●	1.2	0.2	1.2	10	1.16	4.8°	50	4	4	2	10.6	11.1	12.2	13.5
MPXLRBD0150R010N060	●	1.5	0.1	1.5	6	1.44	6.0°	50	4	4	2	6.4	6.7	7.3	8.1
MPXLRBD0150R010N120	●	1.5	0.1	1.5	12	1.44	4.0°	50	4	4	2	12.6	13.2	14.5	16.1
MPXLRBD0150R010N180	●	1.5	0.1	1.5	18	1.44	3.0°	60	4	4	2	18.9	19.7	21.7	24.0
MPXLRBD0150R020N060	●	1.5	0.2	1.5	6	1.44	6.0°	50	4	4	2	6.4	6.7	7.3	8.1
MPXLRBD0150R020N120	●	1.5	0.2	1.5	12	1.44	4.0°	50	4	4	2	12.6	13.2	14.5	16.0
MPXLRBD0150R020N180	●	1.5	0.2	1.5	18	1.44	3.0°	60	4	4	2	18.9	19.7	21.7	*
MPXLRBD0150R030N060	●	1.5	0.3	1.5	6	1.44	6.1°	50	4	4	2	6.3	6.6	7.3	8.0
MPXLRBD0150R030N120	●	1.5	0.3	1.5	12	1.44	4.0°	50	4	4	2	12.6	13.2	14.5	16.0
MPXLRBD0150R030N180	●	1.5	0.3	1.5	18	1.44	3.0°	60	4	4	2	18.9	19.7	21.6	*
MPXLRBD0200R010N080	●	2	0.1	2	8	1.94	4.5°	50	4	4	2	8.5	8.8	9.7	10.8
MPXLRBD0200R010N120	●	2	0.1	2	12	1.94	3.4°	50	4	4	2	12.6	13.2	14.5	16.1
MPXLRBD0200R010N160	●	2	0.1	2	16	1.94	2.8°	60	4	4	2	16.8	17.6	19.3	*
MPXLRBD0200R010N200	●	2	0.1	2	20	1.94	2.3°	60	4	4	2	21.0	21.9	24.1	*
MPXLRBD0200R010N240	●	2	0.1	2	24	1.94	2.0°	70	4	4	2	25.2	26.3	*	*
MPXLRBD0200R020N080	●	2	0.2	2	8	1.94	4.5°	50	4	4	2	8.5	8.8	9.7	10.7
MPXLRBD0200R020N120	●	2	0.2	2	12	1.94	3.4°	50	4	4	2	12.6	13.2	14.5	*
MPXLRBD0200R020N160	●	2	0.2	2	16	1.94	2.8°	60	4	4	2	16.8	17.6	19.3	*
MPXLRBD0200R020N200	●	2	0.2	2	20	1.94	2.3°	60	4	4	2	21.0	21.9	24.0	*
MPXLRBD0200R020N240	●	2	0.2	2	24	1.94	2.0°	70	4	4	2	25.1	26.3	*	*
MPXLRBD0200R030N080	●	2	0.3	2	8	1.94	4.5°	50	4	4	2	8.5	8.8	9.7	10.7
MPXLRBD0200R030N120	●	2	0.3	2	12	1.94	3.5°	50	4	4	2	12.6	13.2	14.5	16.0
MPXLRBD0200R030N160	●	2	0.3	2	16	1.94	2.8°	60	4	4	2	16.8	17.5	19.2	*
MPXLRBD0200R030N200	●	2	0.3	2	20	1.94	2.3°	60	4	4	2	21.0	21.9	24.0	*
MPXLRBD0200R030N240	●	2	0.3	2	24	1.94	2.0°	70	4	4	2	25.1	26.3	*	*
MPXLRBD0300R010N080	●	3	0.1	3	8	2.9	5.7°	60	6	4	2	8.4	8.8	9.6	10.7
MPXLRBD0300R010N120	●	3	0.1	3	12	2.9	4.5°	60	6	4	2	12.6	13.1	14.4	16.0
MPXLRBD0300R010N180	●	3	0.1	3	18	2.9	3.4°	70	6	4	2	18.8	19.7	21.6	23.9
MPXLRBD0300R010N240	●	3	0.1	3	24	2.9	2.8°	70	6	4	2	25.1	26.2	28.8	*
MPXLRBD0300R010N300	●	3	0.1	3	30	2.9	2.3°	70	6	4	2	31.3	32.7	35.9	*
MPXLRBD0300R010N360	●	3	0.1	3	36	2.9	2.0°	90	6	4	2	37.6	39.3	*	*
MPXLRBD0300R020N120	●	3	0.2	3	12	2.9	4.5°	60	6	4	2	12.6	13.1	14.4	15.9
MPXLRBD0300R020N180	●	3	0.2	3	18	2.9	3.4°	60	6	4	2	18.8	19.6	21.6	23.9
MPXLRBD0300R020N240	●	3	0.2	3	24	2.9	2.8°	70	6	4	2	25.1	26.2	28.7	*
MPXLRBD0300R020N300	●	3	0.2	3	30	2.9	2.3°	70	6	4	2	31.3	32.7	35.9	*
MPXLRBD0300R020N360	●	3	0.2	3	36	2.9	2.0°	90	6	4	2	37.6	39.3	43.1	*
MPXLRBD0300R030N120	●	3	0.3	3	12	2.9	4.5°	60	6	4	2	12.5	13.1	14.4	15.9

\* Keine Interferenz

# MPXLRB

Bestellnummer	Lager	DC	RE	APMX	LU	DN	B2	LF	DCON	ZEFP	Typ	Effektive Länge bei Neigungswinkel			
												30°	1°	2°	3°
MPXLRBD0300R030N180	●	3	0.3	3	18	2.9	3.5°	60	6	4	2	18.8	19.6	21.5	23.9
MPXLRBD0300R030N240	●	3	0.3	3	24	2.9	2.8°	70	6	4	2	25.1	26.2	28.7	*
MPXLRBD0300R030N300	●	3	0.3	3	30	2.9	2.3°	70	6	4	2	31.3	32.7	35.9	*
MPXLRBD0300R030N360	●	3	0.3	3	36	2.9	2.0°	90	6	4	2	37.6	39.2	*	*
MPXLRBD0300R050N120	●	3	0.5	3	12	2.9	4.6°	60	6	4	2	12.5	13.1	14.3	15.8
MPXLRBD0300R050N180	●	3	0.5	3	18	2.9	3.5°	60	6	4	2	18.8	19.6	21.5	23.8
MPXLRBD0300R050N240	●	3	0.5	3	24	2.9	2.8°	70	6	4	2	25.1	26.2	28.7	*
MPXLRBD0300R050N300	●	3	0.5	3	30	2.9	2.3°	70	6	4	2	31.3	32.7	35.9	*
MPXLRBD0300R050N360	●	3	0.5	3	36	2.9	2.0°	90	6	4	2	37.6	39.2	*	*
MPXLRBD0400R010N160	●	4	0.1	4	16	3.9	2.8°	70	6	4	2	16.7	17.5	19.2	*
MPXLRBD0400R010N240	●	4	0.1	4	24	3.9	2.0°	70	6	4	2	25.1	26.2	*	*
MPXLRBD0400R010N320	●	4	0.1	4	32	3.9	1.6°	70	6	4	2	33.4	34.9	*	*
MPXLRBD0400R010N480	●	4	0.1	4	48	3.9	1.1°	90	6	4	2	50.1	52.3	*	*
MPXLRBD0400R020N160	●	4	0.2	4	16	3.9	2.8°	70	6	4	2	16.7	17.5	19.2	*
MPXLRBD0400R020N240	●	4	0.2	4	24	3.9	2.0°	70	6	4	2	25.1	26.2	*	*
MPXLRBD0400R020N320	●	4	0.2	4	32	3.9	1.6°	70	6	4	2	33.4	34.9	*	*
MPXLRBD0400R020N480	●	4	0.2	4	48	3.9	1.1°	90	6	4	2	50.1	52.3	*	*
MPXLRBD0400R030N160	●	4	0.3	4	16	3.9	2.8°	70	6	4	2	16.7	17.5	19.1	*
MPXLRBD0400R030N240	●	4	0.3	4	24	3.9	2.0°	70	6	4	2	25.1	26.2	*	*
MPXLRBD0400R030N320	●	4	0.3	4	32	3.9	1.6°	70	6	4	2	33.4	34.9	*	*
MPXLRBD0400R030N480	●	4	0.3	4	48	3.9	1.1°	90	6	4	2	50.1	52.3	*	*
MPXLRBD0400R050N160	●	4	0.5	4	16	3.9	2.8°	70	6	4	2	16.7	17.4	19.1	*
MPXLRBD0400R050N240	●	4	0.5	4	24	3.9	2.0°	70	6	4	2	25.1	26.2	*	*
MPXLRBD0400R050N320	●	4	0.5	4	32	3.9	1.6°	70	6	4	2	33.4	34.9	*	*
MPXLRBD0400R050N480	●	4	0.5	4	48	3.9	1.1°	90	6	4	2	50.1	52.3	*	*
MPXLRBD0600R010N240	●	6	0.1	6	24	5.85	—	70	6	4	3	*	*	*	*
MPXLRBD0600R010N480	●	6	0.1	6	48	5.85	—	100	6	4	3	*	*	*	*
MPXLRBD0600R020N240	●	6	0.2	6	24	5.85	—	70	6	4	3	*	*	*	*
MPXLRBD0600R020N480	●	6	0.2	6	48	5.85	—	100	6	4	3	*	*	*	*
MPXLRBD0600R030N240	●	6	0.3	6	24	5.85	—	70	6	4	3	*	*	*	*
MPXLRBD0600R030N480	●	6	0.3	6	48	5.85	—	100	6	4	3	*	*	*	*
MPXLRBD0600R050N240	●	6	0.5	6	24	5.85	—	70	6	4	3	*	*	*	*
MPXLRBD0600R050N480	●	6	0.5	6	48	5.85	—	100	6	4	3	*	*	*	*

\* Keine Interferenz

# MPXLRB

## SCHNITTDATENEMPFEHLUNGEN

### SCHULTERFRÄSEN

Material	DC	LU	n	Vf	ap	ae	
Baustahl, C-Stahl, legierter Stahl, vergüteter Stahl, ausscheidungsgehärteter, rostfreier Stahl (< 450 HB)	0.2	0.5	30000	180	0.003	0.04	
		1	30000	120	0.003	0.04	
	0.3	1	30000	210	0.003	0.08	
		2	30000	120	0.003	0.08	
	0.4	2	31000	970	0.005	0.10	
		3	31000	790	0.004	0.10	
		4	31000	540	0.003	0.10	
	0.5	2	31000	1500	0.006	0.12	
		3	31000	1300	0.005	0.12	
		4	31000	970	0.004	0.12	
		5	25000	790	0.004	0.12	
	0.6	2	31000	2100	0.020	0.13	
		4	25000	1300	0.015	0.13	
		6	20000	790	0.008	0.13	
	0.8	4	25000	3200	0.025	0.20	
		6	20000	2100	0.020	0.20	
	1	3	24000	2400	0.045	0.30	
		4	24000	1900	0.040	0.30	
		5	24000	1800	0.035	0.25	
		6	20000	1400	0.030	0.25	
		8	20000	1000	0.020	0.20	
		10	15000	800	0.015	0.10	
		12	15000	370	0.010	0.01	
		1.2	10	18000	1500	0.030	0.25
		1.5	6	20000	2400	0.050	0.40
			12	15000	1400	0.040	0.30
	2	18	12000	670	0.010	0.15	
		8	15000	2600	0.050	0.50	
		12	15000	2100	0.045	0.50	
		16	14000	1900	0.040	0.35	
		20	14000	1100	0.015	0.25	
	3	24	9300	930	0.010	0.20	
		8	12000	3300	0.100	0.80	
		12	12000	3100	0.080	0.80	
		18	11000	3100	0.070	0.70	
		24	11000	2600	0.060	0.50	
		30	9000	1300	0.030	0.40	
		36	6200	910	0.010	0.30	
	4	16	9000	3200	0.100	1.00	
		24	7900	2500	0.085	0.80	
32		6900	1600	0.040	0.70		
48		4800	740	0.010	0.35		
6	24	5500	2700	0.120	1.50		
	48	3800	1200	0.050	1.20		

# MPXLRB

## SCHULTERFRÄSEN

Material	DC	LU	n	Vf	ap	ae
Austenitische rostfreie Stähle, Titanlegierungen	0.2	0.5	33000	170	0.003	0.04
		1	30000	110	0.003	0.04
	0.3	1	30000	200	0.003	0.08
		2	30000	110	0.003	0.08
	0.4	2	31000	930	0.005	0.10
		3	31000	750	0.004	0.10
		4	31000	510	0.003	0.10
	0.5	2	31000	1400	0.006	0.12
		3	31000	1200	0.005	0.12
		4	31000	930	0.004	0.12
		5	25000	750	0.004	0.12
	0.6	2	31000	2000	0.020	0.13
		4	25000	1200	0.015	0.13
		6	20000	750	0.008	0.13
	0.8	4	25000	3100	0.025	0.20
		6	20000	2000	0.020	0.20
	1	3	23000	2300	0.045	0.30
		4	23000	1800	0.040	0.30
		5	23000	1700	0.035	0.25
		6	19000	1300	0.030	0.25
		8	19000	1000	0.020	0.20
		10	14000	770	0.015	0.10
	1.2	12	14000	350	0.010	0.01
		10	17000	1400	0.030	0.25
	1.5	6	19000	2300	0.050	0.40
		12	14000	1300	0.040	0.30
		18	11000	640	0.010	0.15
	2	8	14000	2500	0.050	0.50
		12	14000	2000	0.045	0.50
		16	13000	1800	0.040	0.35
		20	13000	1100	0.015	0.25
		24	8900	890	0.010	0.20
	3	8	11000	3200	0.100	0.80
		12	11000	2900	0.080	0.80
		18	11000	2900	0.070	0.70
		24	10000	2500	0.060	0.50
		30	8600	1200	0.030	0.40
		36	5900	870	0.010	0.30
	4	16	8600	3100	0.100	1.00
		24	7500	2400	0.085	0.80
32		6600	1600	0.040	0.70	
48		4600	710	0.010	0.35	
6	24	5200	2600	0.120	1.50	
	48	3600	1100	0.05	1.20	

M

S

# MPXLRB

## SCHULTERFRÄSEN

Material	DC	LU	n	Vf	ap	ae
N Kupfer, Kupferlegierungen	0.2	0.5	30000	150	0.003	0.08
		1	30000	100	0.003	0.08
	0.3	1	30000	180	0.003	0.16
		2	30000	100	0.003	0.16
	0.4	2	31000	810	0.005	0.20
		3	31000	660	0.004	0.20
		4	31000	450	0.003	0.20
	0.5	2	31000	1300	0.006	0.24
		3	31000	1100	0.005	0.24
		4	31000	8100	0.004	0.24
	0.6	5	25000	660	0.004	0.24
		2	31000	1800	0.020	0.26
		4	25000	1100	0.015	0.26
	0.8	6	20000	660	0.008	0.26
		4	25000	2700	0.025	0.40
		6	20000	1800	0.020	0.40
	1	3	20000	2000	0.045	0.60
		4	20000	1600	0.040	0.60
		5	20000	1500	0.035	0.50
		6	17000	1200	0.030	0.50
		8	17000	880	0.020	0.40
		10	13000	670	0.015	0.20
	1.2	12	13000	310	0.010	0.02
		10	15000	1300	0.030	0.50
	1.5	6	14700	1700	0.050	0.80
		12	11000	1000	0.040	0.60
		18	8600	480	0.010	0.30
	2	8	11000	1900	0.050	1.00
		12	11000	1500	0.045	1.00
		16	10000	1300	0.040	0.70
		20	10000	830	0.015	0.50
		24	6700	670	0.010	0.40
	3	8	8600	2400	0.100	1.60
		12	8600	2200	0.080	1.60
		18	8300	2200	0.070	1.40
		24	8000	1900	0.060	1.00
		30	6500	950	0.030	0.80
		36	4500	660	0.010	0.60
	4	16	6500	2300	0.100	2.00
		24	5700	1800	0.085	1.60
		32	5000	1200	0.040	1.40
		48	3400	530	0.010	0.70
	6	24	4000	1900	0.120	3.00
		48	2700	870	0.050	2.40

# MPXLRB

## SCHULTERFRÄSEN

Material	DC	LU	n	Vf	ap	ae
H Gehärteter Stahl (45 – 52 HRC)	0.2	0.5	30000	150	0.003	0.04
		1	30000	100	0.003	0.04
	0.3	1	30000	180	0.003	0.08
		2	30000	100	0.003	0.08
	0.4	2	31000	810	0.005	0.10
		3	31000	660	0.004	0.10
		4	31000	450	0.003	0.10
	0.5	2	31000	1300	0.006	0.12
		3	31000	1100	0.005	0.12
		4	31000	810	0.004	0.12
		5	25000	660	0.004	0.12
	0.6	2	31000	1800	0.020	0.13
		4	25000	1100	0.015	0.13
		6	20000	660	0.008	0.13
	0.8	4	25000	2700	0.025	0.20
		6	20000	1800	0.020	0.20
	1	3	20000	2000	0.045	0.30
		4	20000	1600	0.040	0.30
		5	20000	1500	0.035	0.25
		6	17000	1200	0.030	0.25
		8	17000	880	0.020	0.20
		10	13000	670	0.015	0.10
	1.2	12	13000	310	0.010	0.01
		10	15000	1300	0.030	0.25
	1.5	6	17000	2000	0.050	0.40
		12	13000	1200	0.040	0.30
		18	10000	560	0.010	0.15
	2	8	13000	2200	0.050	0.50
		12	13000	1800	0.045	0.50
		16	12000	1600	0.040	0.35
		20	12000	960	0.015	0.25
		24	7800	780	0.010	0.20
	3	8	10000	2800	0.100	0.80
		12	10000	2600	0.080	0.80
		18	9600	2600	0.070	0.70
		24	9300	2200	0.060	0.50
		30	7500	1100	0.030	0.40
		36	5200	760	0.010	0.30
	4	16	7500	2700	0.100	1.00
		24	6600	2100	0.085	0.80
		32	5800	1400	0.040	0.70
	6	48	4000	620	0.010	0.35
		24	4600	2263	0.120	1.50
		48	3200	1000	0.050	1.20

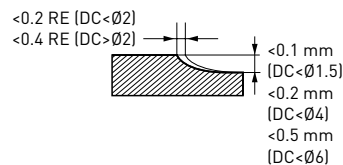



# MP2ES

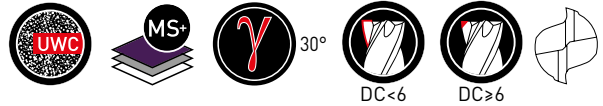

## SCHAFTFRÄSER, 2 SCHNEIDEN, FÜR LANG/ UND MEHRSPINDELDREHAUTOMATEN

P M S N H

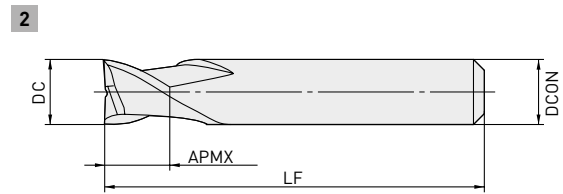
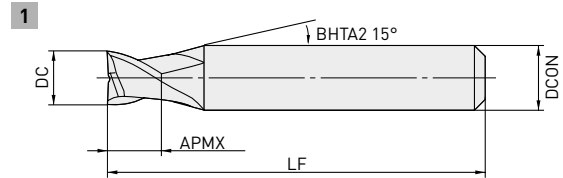

	3 < DC <= 10	
	- 0.010	- 0.030
	4 < DCON <= 6	7 < DCON <= 10
	0 - 0.008	0 - 0.009

Bestellnummer	Lager	DC	APMX	LF	DCON	ZEFP	Typ
MP2ESD0300S04	●	3	4.5	50	4	2	1
MP2ESD0400S04	●	4	6	50	4	2	2
MP2ESD0500S06	●	5	7.5	50	6	2	1
MP2ESD0600S06	●	6	9	50	6	2	2
MP2ESD0700S07	●	7	10.5	50	7	2	2
MP2ESD0800S08	●	8	12	50	8	2	2
MP2ESD1000S10	●	10	15	50	10	2	2



# MP2ES

## SCHNITTDATENEMPFEHLUNGEN

### SCHULTERFRÄSEN

Material	DC	n	Vf	ap	ae	
P C-Stahl, Duktiler Guss, legierter Stahl (~30 HRC)	3	10000	600	3	0.6	
	4	7500	600	4	0.6	
	5	6000	600	5	0.6	
	6	5000	600	6	0.6	
	7	4500	560	7	0.6	
	8	4000	520	8	0.6	
	10	3200	450	10	0.6	
	legierter Werkzeugstahl, Werkzeugstahl, vergüteter Stahl	3	7000	400	3	0.6
		4	5200	400	4	0.6
		5	4200	400	5	0.6
6		3500	400	6	0.6	
7		3200	360	7	0.6	
8		2800	350	8	0.6	
M austenitischer rostfreier Stahl, Titanlegierung	3	6000	300	3	0.6	
	4	4500	300	4	0.6	
	5	3600	300	5	0.6	
	6	3000	300	6	0.6	
	7	2700	280	7	0.6	
S Kupfer, Kupferlegierungen	8	2400	260	8	0.6	
	10	1900	230	10	0.6	
	3	13000	780	3	0.6	
	4	9500	760	4	0.6	
N Kupfer, Kupferlegierungen	5	7600	760	5	0.6	
	6	6400	770	6	0.6	
	7	5500	680	7	0.6	
	8	4800	620	8	0.6	
	10	3800	530	10	0.6	
H gehärteter Stahl (45-55 HRC)	3	5000	120	3	0.2	
	4	4000	120	4	0.2	
	5	3200	120	5	0.2	
	6	2700	120	6	0.2	
	7	2300	110	7	0.2	
	8	2000	110	8	0.2	
	10	1600	100	10	0.2	

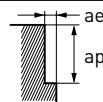

1. Beim Fräsen von austenitischen rostfreien Stählen wird die Verwendung eines wasserlöslichen Kühlschmierstoffs empfohlen.
2. Bei geringen Schnitttiefen können Drehzahl und Vorschub erhöht werden.
3. Beim Bohren Vorschub auf maximal 1/3 der oben angegebenen Werte einstellen.
4. Falls die Stabilität der Maschine oder der Werkstückbefestigung jedoch sehr gering ist, können Vibrationen auftreten.  
In diesem Fall müssen Drehzahl und Vorschubgeschwindigkeit entsprechend reduziert oder eine geringere Schnitttiefe eingestellt werden.

# MP2ES

## NUTENFRÄSEN

Material	DC	n	Vf	ap	
P C-Stahl, Duktiler Guss, legierter Stahl (<math>-30\text{ HRC}</math>)	3	10000	600	0.6	
	4	7500	600	0.6	
	5	6000	600	0.6	
	6	5000	600	0.6	
	7	4500	560	0.6	
	8	4000	520	0.6	
	10	3200	450	0.6	
	legierter Werkzeugstahl, Werkzeugstahl, vergüteter Stahl	3	7000	400	0.6
		4	5200	400	0.6
		5	4200	400	0.6
6		3500	400	0.6	
7		3200	360	0.6	
8		2800	350	0.6	
10		2200	300	0.6	
M austenitischer rostfreier Stahl, Titanlegierung	3	6000	300	0.6	
	4	4500	300	0.6	
	5	3600	300	0.6	
	6	3000	300	0.6	
	S	7	2700	280	0.6
		8	2400	260	0.6
10		1900	230	0.6	
N Kupfer, Kupferlegierungen	3	13000	780	0.6	
	4	9500	760	0.6	
	5	7600	760	0.6	
	6	6400	770	0.6	
	7	5500	680	0.6	
	8	4800	620	0.6	
H gehärteter Stahl (45-55 HRC)	10	3800	530	0.6	
	3	5000	120	0.2	
	4	4000	120	0.2	
	5	3200	120	0.2	
	6	2700	120	0.2	
	7	2300	110	0.2	
	8	2000	110	0.2	
10	1600	100	0.2		

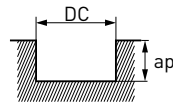

1. Beim Fräsen von austenitischen rostfreien Stählen wird die Verwendung eines wasserlöslichen Kühlschmierstoffs empfohlen.
2. Bei geringen Schnitttiefen können Drehzahl und Vorschub erhöht werden.
3. Beim Bohren Vorschub auf maximal  $1/3$  der oben angegebenen Werte einstellen.
4. Falls die Stabilität der Maschine oder der Werkstückbefestigung jedoch sehr gering ist, können Vibrationen auftreten. In diesem Fall müssen Drehzahl und Vorschubgeschwindigkeit entsprechend reduziert oder eine geringere Schnitttiefe eingestellt werden.

# MP3ES



## SCHAFTFRÄSER, 3 SCHNEIDEN, FÜR LANG/ UND MEHRSPINDELDREHAUTOMATEN

P M S N H

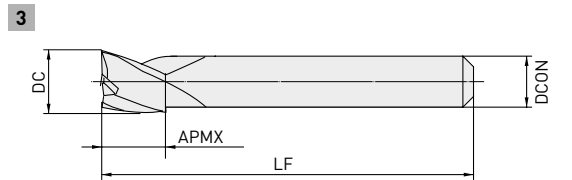
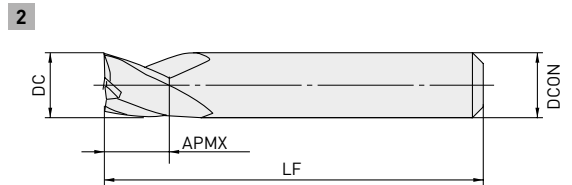
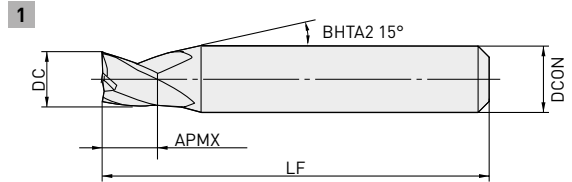

$3 \leq DC \leq 12$

- 0.010
- 0.030



$4 \leq DCON \leq 6$     $7 \leq DCON \leq 10$     $DCON = 12$

- |         |         |         |
|---------|---------|---------|
| 0       | 0       | 0       |
| - 0.008 | - 0.009 | - 0.011 |

Bestellnummer	Lager	DC	APMX	LF	DCON	ZEFP	Typ
MP3ESD0300S04	●	3	4.5	50	4	3	1
MP3ESD0400S04	●	4	6	50	4	3	2
MP3ESD0500S06	●	5	7.5	50	6	3	1
MP3ESD0600S06	●	6	9	50	6	3	2
MP3ESD0700S07	●	7	10.5	50	7	3	2
MP3ESD0800S08	●	8	12	50	8	3	2
MP3ESD0900S10	●	9	13.5	50	10	3	1
MP3ESD1000S10	●	10	15	50	10	3	2
MP3ESD1200S10	●	12	15	50	10	3	3
MP3ESD1200S12	●	12	15	50	12	3	2

# MP3ES

## SCHNITTDATENEMPFEHLUNGEN

### SCHULTERFRÄSEN

Material	DC	n	Vf	ap	ae	
P C-Stahl, Duktiler Guss, legierter Stahl (~30 HRC)	3	10000	720	3	0.6	
	4	7500	720	4	0.6	
	5	6000	720	5	0.6	
	6	5000	720	6	0.6	
	7	4500	670	7	0.6	
	8	4000	620	8	0.6	
	9	3500	580	9	0.6	
	10	3200	540	10	0.6	
	12	2700	490	12	0.6	
	legierter Werkzeugstahl, Werkzeugstahl, vergüteter Stahl	3	7000	480	3	0.6
		4	5200	480	4	0.6
		5	4200	480	5	0.6
6		3500	480	6	0.6	
7		3200	440	7	0.6	
8		2800	420	8	0.6	
9		2500	380	9	0.6	
10		2200	360	10	0.6	
12		1900	320	12	0.6	
M S austenitischer rostfreier Stahl, Titanlegierung		3	6000	360	3	0.6
		4	4500	360	4	0.6
		5	3600	360	5	0.6
	6	3000	360	6	0.6	
	7	2700	340	7	0.6	
	8	2400	310	8	0.6	
	9	2100	290	9	0.6	
	10	1900	280	10	0.6	
	12	1600	250	12	0.6	
	N Kupfer, Kupferlegierungen	3	13000	940	3	0.6
		4	9500	910	4	0.6
		5	7600	910	5	0.6
6		6400	920	6	0.6	
7		5500	820	7	0.6	
8		4800	740	8	0.6	
9		4200	700	9	0.6	
10		3800	640	10	0.6	
12		3200	580	12	0.6	

# MP3ES

## SCHULTERFRÄSEN

Material	DC	n	Vf	ap	ae
H gehärteter Stahl (45–55 HRC)	3	5000	140	3	0.2
	4	4000	140	4	0.2
	5	3200	140	5	0.2
	6	2700	140	6	0.2
	7	2300	130	7	0.2
	8	2000	130	8	0.2
	9	1800	130	9	0.2
	10	1600	120	10	0.2
	12	1300	120	12	0.2

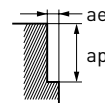

1. Beim Fräsen von austenitischen rostfreien Stählen wird die Verwendung eines wasserlöslichen Kühlschmierstoffs empfohlen.
2. Bei geringen Schnitttiefen können Drehzahl und Vorschub erhöht werden.
3. Beim Bohren Vorschub auf maximal 1/3 der oben angegebenen Werte einstellen.
4. Falls die Stabilität der Maschine oder der Werkstückbefestigung jedoch sehr gering ist, können Vibrationen auftreten.  
In diesem Fall müssen Drehzahl und Vorschubgeschwindigkeit entsprechend reduziert oder eine geringere Schnitttiefe eingestellt werden.

## NUTENFRÄSEN

Material	DC	n	Vf	ap	
C-Stahl, Duktiler Guss, legierter Stahl (-30 HRC)	3	10000	720	0.6	
	4	7500	720	0.6	
	5	6000	720	0.6	
	6	5000	720	0.6	
	7	4500	670	0.6	
	8	4000	620	0.6	
	9	3500	580	0.6	
	10	3200	540	0.6	
	12	2700	490	0.6	
	P legierter Werkzeugstahl, Werkzeugstahl, vergüteter Stahl	3	7000	480	0.6
		4	5200	480	0.6
		5	4200	480	0.6
6		3500	480	0.6	
7		3200	440	0.6	
8		2800	420	0.6	
9		2500	380	0.6	
10		2200	360	0.6	
12		1900	320	0.6	

# MP3ES

## NUTENFRÄSEN

Material	DC	n	Vf	ap	
M austenitische rostfreier Stahl, Titanlegierung	3	6000	360	0.6	
	4	4500	360	0.6	
	5	3600	360	0.6	
	6	3000	360	0.6	
	7	2700	340	0.6	
	8	2400	310	0.6	
	9	2100	290	0.6	
	10	1900	280	0.6	
	12	1600	250	0.6	
	N Kupfer, Kupferlegierungen	3	13000	940	0.6
		4	9500	910	0.6
		5	7600	910	0.6
6		6400	920	0.6	
7		5500	820	0.6	
8		4800	740	0.6	
9		4200	700	0.6	
10		3800	640	0.6	
H gehärteter Stahl (45-55 HRC)	3	5000	140	0.2	
	4	4000	140	0.2	
	5	3200	140	0.2	
	6	2700	140	0.2	
	7	2300	130	0.2	
	8	2000	130	0.2	
	9	1800	130	0.2	
	10	1600	120	0.2	
	12	1300	120	0.2	

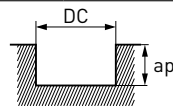

1. Beim Fräsen von austenitischen rostfreien Stählen wird die Verwendung eines wasserlöslichen Kühlschmierstoffs empfohlen.
2. Bei geringen Schnitttiefen können Drehzahl und Vorschub erhöht werden.
3. Beim Bohren Vorschub auf maximal 1/3 der oben angegebenen Werte einstellen.
4. Falls die Stabilität der Maschine oder der Werkstückbefestigung jedoch sehr gering ist, können Vibrationen auftreten.  
In diesem Fall müssen Drehzahl und Vorschubgeschwindigkeit entsprechend reduziert oder eine geringere Schnitttiefe eingestellt werden.



# MP4EC

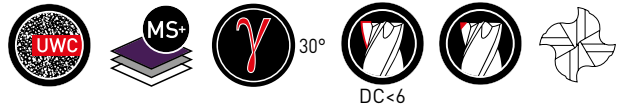

## SCHAFTFRÄSER, 4 SCHNEIDEN, FÜR LANG/ MEHRSPINDELDREHAUTOMATEN

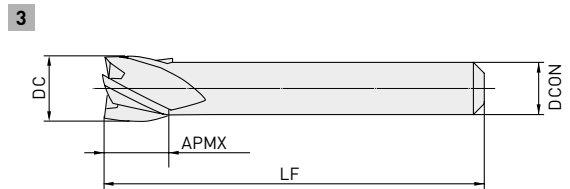
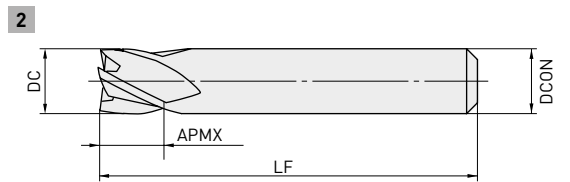
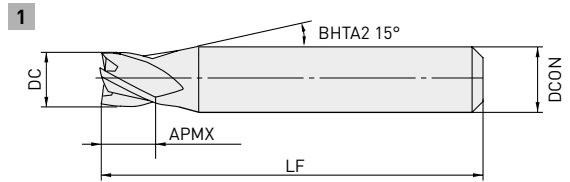

	3<math>DC \leq 12</math>	DC=14	
	- 0.010	- 0.010	
	- 0.030	- 0.040	
	4<math>DCON \leq 6</math>	7<math>DCON \leq 10</math>	DCON=12
	0	0	0
	- 0.008	- 0.009	- 0.011

Bestellnummer	Lager	DC	APMX	LF	DCON	ZEFP	Typ
MP4ECD0300S04	●	3	4.5	50	4	4	1
MP4ECD0350S04	●	3.5	5	50	4	4	1
MP4ECD0400S04	●	4	6	50	4	4	2
MP4ECD0500S06	●	5	7.5	50	6	4	1
MP4ECD0600S06	●	6	9	50	6	4	2
MP4ECD0700S07	●	7	10.5	50	7	4	2
MP4ECD0800S07	●	8	12	50	7	4	3
MP4ECD0800S08	●	8	12	50	8	4	2
MP4ECD0900S10	●	9	13.5	50	10	4	1
MP4ECD1000S07	●	10	15	50	7	4	3
MP4ECD1000S10	●	10	15	50	10	4	2
MP4ECD1200S10	●	12	15	50	10	4	3
MP4ECD1200S12	●	12	15	50	12	4	2
MP4ECD1400S10	●	14	15	50	10	4	3

# MP4EC

## SCHNITTDATENEMPFEHLUNGEN

### SCHULTERFRÄSEN

Material	DC	n	Vf	ap	ae	
P C-Stahl, Duktiler Guss, legierter Stahl (~30 HRC)	3	10000	900	3	0.6	
	3.5	8500	900	3.5	0.6	
	4	7500	900	4	0.6	
	5	6000	900	5	0.6	
	6	5000	900	6	0.6	
	7	4500	840	7	0.6	
	8	4000	780	8	0.6	
	9	3500	720	9	0.6	
	10	3200	680	10	0.6	
	12	2700	620	12	0.6	
	14	2300	550	14	0.6	
	S Legierter Werkzeugstahl, Werkzeugstahl, vergüteter Stahl	3	7000	600	3	0.6
		3.5	6000	600	3.5	0.6
		4	5200	600	4	0.6
5		4200	600	5	0.6	
6		3500	600	6	0.6	
7		3200	540	7	0.6	
8		2800	520	8	0.6	
9		2500	480	9	0.6	
10		2200	450	10	0.6	
12		1900	410	12	0.6	
14		1600	350	14	0.6	
M Austenitischer rostfreier Stahl, Titanlegierung		3	6000	450	3	0.6
		3.5	5100	450	3.5	0.6
		4	4500	450	4	0.6
	5	3600	450	5	0.6	
	6	3000	450	6	0.6	
	7	2700	420	7	0.6	
	8	2400	390	8	0.6	
	9	2100	360	9	0.6	
	10	1900	340	10	0.6	
	12	1600	310	12	0.6	
	14	1400	280	14	0.6	
	N Kupfer, Kupferlegierungen	3	13000	1200	3	0.6
		3.5	11000	1200	3.5	0.6
		4	9500	1100	4	0.6
5		7600	1100	5	0.6	
6		6400	1100	6	0.6	
7		5500	1000	7	0.6	
8		4800	940	8	0.6	
9		4200	860	9	0.6	
10		3800	810	10	0.6	
12		3200	730	12	0.6	
14		2700	650	14	0.6	

# MP4EC

## SCHULTERFRÄSEN

Material	DC	n	Vf	ap	ae
H Gehärteter Stahl (45-55 HRC)	3	5000	180	3	0.2
	3.5	4500	180	3.5	0.2
	4	4000	180	4	0.2
	5	3200	180	5	0.2
	6	2700	180	6	0.2
	7	2300	160	7	0.2
	8	2000	160	8	0.2
	9	1800	150	9	0.2
	10	1600	140	10	0.2
	12	1300	120	12	0.2
	14	1200	120	14	0.2

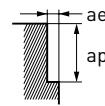

1. Beim Fräsen von austenitischen rostfreien Stählen wird die Verwendung eines wasserlöslichen Kühlschmierstoffs empfohlen.
2. Bei geringen Schnitttiefen können Drehzahl und Vorschub erhöht werden.
3. Beim Bohren Vorschub auf maximal 1/3 der oben angegebenen Werte einstellen.
4. Falls die Stabilität der Maschine oder der Werkstückbefestigung jedoch sehr gering ist, können Vibrationen auftreten.  
In diesem Fall müssen Drehzahl und Vorschubgeschwindigkeit entsprechend reduziert oder eine geringere Schnitttiefe eingestellt werden.

## NUTENFRÄSEN

Material	DC	n	Vf	ap	
C-Stahl, Duktiler Guss, legierter Stahl (-30 HRC)	3	10000	900	0.6	
	3.5	8500	900	0.6	
	4	7500	900	0.6	
	5	6000	900	0.6	
	6	5000	900	0.6	
	7	4500	840	0.6	
	8	4000	780	0.6	
	9	3500	720	0.6	
	10	3200	680	0.6	
	12	2700	620	0.6	
	14	2300	550	0.6	
	P Legierter Werkzeugstahl, Werkzeugstahl, vergüteter Stahl	3	7000	600	0.6
		3.5	6000	600	0.6
		4	5200	600	0.6
5		4200	600	0.6	
6		3500	600	0.6	
7		3200	540	0.6	
8		2800	520	0.6	
9		2500	480	0.6	
10		2200	450	0.6	
12		1900	410	0.6	
14		1600	350	0.6	

# MP4EC

## NUTENFRÄSEN

Material	DC	n	Vf	ap	
M Austenitischer rostfreier Stahl, Titanlegierung	3	6000	450	0.6	
	3.5	5100	450	0.6	
	4	4500	450	0.6	
	5	3600	450	0.6	
	6	3000	450	0.6	
	7	2700	420	0.6	
	8	2400	390	0.6	
	9	2100	360	0.6	
	10	1900	340	0.6	
	12	1600	310	0.6	
	14	1400	280	0.6	
	N Kupfer, Kupferlegierungen	3	13000	1200	0.6
		3.5	11000	1200	0.6
		4	9500	1100	0.6
5		7600	1100	0.6	
6		6400	1100	0.6	
7		5500	1000	0.6	
8		4800	940	0.6	
9		4200	860	0.6	
10		3800	810	0.6	
12		3200	730	0.6	
14		2700	650	0.6	
H Gehärteter Stahl (45 – 55 HRC)		3	5000	180	0.2
		3.5	4500	180	0.2
		4	4000	180	0.2
	5	3200	180	0.2	
	6	2700	180	0.2	
	7	2300	160	0.2	
	8	2000	160	0.2	
	9	1800	150	0.2	
	10	1600	140	0.2	
	12	1300	120	0.2	
	14	1200	120	0.2	

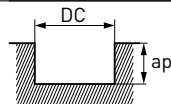

1. Beim Fräsen von austenitischen rostfreien Stählen wird die Verwendung eines wasserlöslichen Kühlschmierstoffs empfohlen.
2. Bei geringen Schnitttiefen können Drehzahl und Vorschub erhöht werden.
3. Beim Bohren Vorschub auf maximal 1/3 der oben angegebenen Werte einstellen.
4. Falls die Stabilität der Maschine oder der Werkstückbefestigung jedoch sehr gering ist, können Vibrationen auftreten.  
In diesem Fall müssen Drehzahl und Vorschubgeschwindigkeit entsprechend reduziert oder eine geringere Schnitttiefe eingestellt werden.

# MPSHV/W



## SCHAFTFRÄSER, KURZE SCHNEIDENLÄNGE, 2,5XDC HINTERSCHLIFF, 4-SCHNEIDIGER VARIABLELER SPIRALWINKEL

P M S H

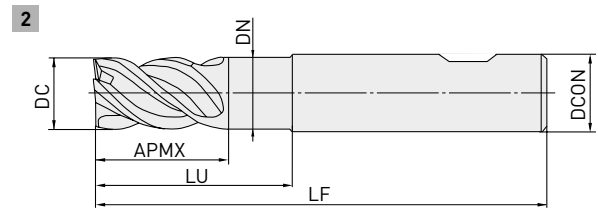
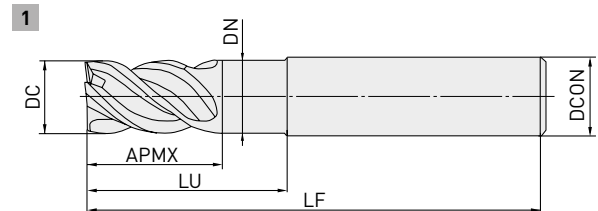

	DC ≤ 12	DC > 12		
	0	0		
	- 0.02	- 0.03		
	DCON = 6	8 ≤ DCON ≤ 10	12 ≤ DCON ≤ 16	DCON = 20
	0	0	0	0
	- 0.008	- 0.009	- 0.011	- 0.013

- Erhöhte Vielseitigkeit, durch den Hinterschliff möglicher Einsatz von bis zu 2,5 × DC für MPSHV

Bestellnummer	Lager	DC	APMX	LU	DN	LF	DCON	ZEFP	Typ
MPSHVD0600N015	●	6	9	15	5.85	50	6	4	1
MPSHVD0600N015W	●	6	9	15	5.85	50	6	4	2
MPSHVD0800N020	●	8	12	20	7.85	60	8	4	1
MPSHVD0800N020W	●	8	12	20	7.85	60	8	4	2
MPSHVD1000N025	●	10	15	25	9.7	70	10	4	1
MPSHVD1000N025W	●	10	15	25	9.7	70	10	4	2
MPSHVD1200N030	●	12	18	30	11.7	75	12	4	1
MPSHVD1200N030W	●	12	18	30	11.7	75	12	4	2
MPSHVD1600N040	●	16	24	40	15.5	90	16	4	1
MPSHVD1600N040W	●	16	24	40	15.5	90	16	4	2
MPSHVD2000N050	●	20	30	50	19.5	110	20	4	1
MPSHVD2000N050W	●	20	30	50	19.5	110	20	4	2

# MPSHV/W

## SCHNITTDATENEMPFEHLUNGEN

### SCHULTERFRÄSEN – (HSC)

Material	DC	n	Vf	ap	ae
P C-Stahl, legierter Stahl, duktiler Gusseisen	6	11000	3100	9	0.12
	8	8000	2600	12	0.16
	10	6400	2600	15	0.2
	12	5300	2500	18	0.24
	16	4000	1900	24	0.32
	20	3200	1500	30	0.4
P C-Stahl, legierter Stahl, vergüteter Stahl, legierter Werkzeugstahl	6	8000	1900	9	0.12
	8	6000	1700	12	0.16
	10	4800	1600	15	0.2
	12	4000	1600	18	0.24
	16	3000	1200	24	0.32
	20	2400	960	30	0.4
M Austenitische rostfreie Stähle, Titanlegierungen	6	6400	1200	9	0.12
	8	4800	1200	12	0.16
S Gehärteter Stahl (40 – 52 HRC)	10	3800	1100	15	0.2
	12	3200	1100	18	0.24
	16	2400	860	24	0.32
	20	1900	680	30	0.4
H Gehärteter Stahl (40 – 52 HRC)	6	5300	640	9	0.12
	8	4000	640	12	0.16
	10	3200	640	15	0.2
	12	2700	540	18	0.24
	16	2000	480	24	0.32
	20	1600	380	30	0.4

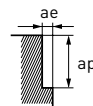

# MPSHV/W

## SCHULTERFRÄSEN — (HPC)

Material	DC	n	Vf	ap	ae	
P C-Stahl, legierter Stahl, duktiler Gusseisen	6	8000	2100	9	1.2	
	8	6000	2000	12	1.6	
	10	4800	2000	15	2	
	12	4000	1900	18	2.4	
	16	3000	1400	24	3.2	
	20	2400	1200	30	4	
	C-Stahl, legierter Stahl, vergüteter Stahl, legierter Werkzeugstahl	6	6400	1300	9	1.2
		8	4800	1400	12	1.6
		10	3800	1400	15	2
		12	3200	1400	18	2.4
16		2400	1100	24	3.2	
M Austenitische rostfreie Stähle, Titanlegierungen	6	5300	1100	9	1.2	
	8	4000	1100	12	1.6	
	10	3200	1100	15	2	
	12	2700	1100	18	2.4	
	16	2000	840	24	3.2	
S Gehärteter Stahl (40 – 52 HRC)	20	1600	670	30	4	
	6	3700	440	9	1.2	
	8	2800	440	12	1.6	
	10	2200	440	15	2	
	12	1900	380	18	2.4	
H	16	1400	340	24	3.2	
	20	1100	260	30	4	

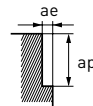



# MPSHV/W

## NUTENFRÄSEN

Material	DC	n	Vf	ap	
P C-Stahl, legierter Stahl, duktiler Gusseisen	6	6400	860	6	
	8	4800	1000	8	
	10	3800	910	10	
	12	3200	910	12	
	16	2400	690	16	
	20	1900	550	20	
	P C-Stahl, legierter Stahl, vergüteter Stahl, legierter Werkzeugstahl	6	5100	630	6
		8	3800	750	8
		10	3100	680	10
		12	2500	660	12
16		1900	500	16	
M Austenitische rostfreie Stähle, Titanlegierungen	6	4200	470	6	
	8	3200	580	8	
	10	2500	500	10	
	12	2100	500	12	
	16	1600	380	16	
S Gehärteter Stahl (40 – 52 HRC)	20	1300	310	20	
	6	1600	190	6	
	8	1200	190	8	
	10	950	150	10	
	12	800	150	12	
H	16	600	120	16	
	20	450	96	20	

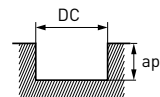

# MPMHV/W



## SCHAFTFRÄSER, MITTLERE SCHNITTLÄNGE, 2,5XDC HINTERSCHLIFF, 4-SCHNEIDIGER VARIABLER SPIRALWINKEL

P M S H

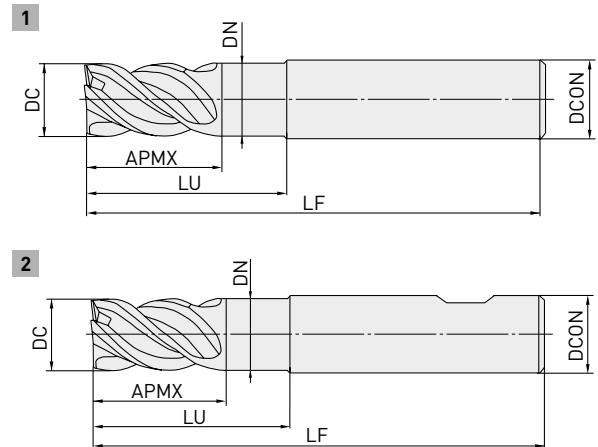

	DC ≤ 12	DC > 12		
	0	0		
	- 0.02	- 0.03		
	DCON = 6	8 ≤ DCON ≤ 10	12 ≤ DCON ≤ 16	DCON = 20
	0	0	0	0
	- 0.008	- 0.009	- 0.011	- 0.013

- Erhöhte Vielseitigkeit, durch den Hinterschliff möglicher Einsatz von bis zu  $2,5 \times DC$  für MPMHV

Bestellnummer	Lager	DC	APMX	LU	DN	LF	DCON	ZEFP	Typ
MPMHVD0600N015	●	6	12	15	5.85	50	6	4	1
MPMHVD0600N015W	●	6	12	15	5.85	50	6	4	2
MPMHVD0800N020	●	8	16	20	7.85	60	8	4	1
MPMHVD0800N020W	●	8	16	20	7.85	60	8	4	2
MPMHVD1000N025	●	10	20	25	9.7	70	10	4	1
MPMHVD1000N025W	●	10	20	25	9.7	70	10	4	2
MPMHVD1200N030	●	12	24	30	11.7	75	12	4	1
MPMHVD1200N030W	●	12	24	30	11.7	75	12	4	2
MPMHVD1600N040	●	16	32	40	15.5	90	16	4	1
MPMHVD1600N040W	●	16	32	40	15.5	90	16	4	2
MPMHVD2000N050	●	20	40	50	19.5	110	20	4	1
MPMHVD2000N050W	●	20	40	50	19.5	110	20	4	2

# MPMHV/W

## SCHNITTDATENEMPFEHLUNGEN

### SCHULTERFRÄSEN – (HSC)

Material	DC	n	Vf	ap	ae	
P C-Stahl, legierter Stahl, duktiler Gusseisen	6	11000	3100	10	0.12	
	8	8000	2600	13.5	0.16	
	10	6400	2600	17	0.2	
	12	5300	2500	20.5	0.24	
	16	4000	1900	27.2	0.32	
	20	3200	1500	34	0.4	
	C-Stahl, legierter Stahl, vergüteter Stahl, legierter Werkzeugstahl	6	8000	1900	10	0.12
		8	6000	1700	13.5	0.16
		10	4800	1600	17	0.2
		12	4000	1600	20.5	0.24
16		3000	1200	27.2	0.32	
20		2400	960	34	0.4	
M Austenitische rostfreie Stähle, Titanlegierungen	6	6400	1200	10	0.12	
	8	4800	1200	13.5	0.16	
	10	3800	1100	17	0.2	
	12	3200	1100	20.5	0.24	
S Gehärteter Stahl (40 – 52 HRC)	16	2400	860	27.2	0.32	
	20	1900	680	34	0.4	
	6	5300	640	10	0.12	
H Gehärteter Stahl (40 – 52 HRC)	8	4000	640	13.5	0.16	
	10	3200	640	17	0.2	
	12	2700	540	20.5	0.24	
	16	2000	480	27.2	0.32	
	20	1600	380	34	0.4	

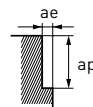

# MPMHV/W

## SCHULTERFRÄSEN — (HPC)

Material	DC	n	Vf	ap	ae	
P C-Stahl, legierter Stahl, duktiler Gusseisen	6	8000	2100	10	1.2	
	8	6000	2000	13.5	1.6	
	10	4800	2000	17	2	
	12	4000	1900	20.5	2.4	
	16	3000	1400	27.2	3.2	
	20	2400	1200	34	4	
	C-Stahl, legierter Stahl, vergüteter Stahl, legierter Werkzeugstahl	6	6400	1300	10	1.2
		8	4800	1400	13.5	1.6
		10	3800	1400	17	2
		12	3200	1400	20.5	2.4
16		2400	1100	27.2	3.2	
M Austenitische rostfreie Stähle, Titanlegierungen	6	5300	1100	10	1.2	
	8	4000	1100	13.5	1.6	
	10	3200	1100	17	2	
	12	2700	1100	20.5	2.4	
	16	2000	840	27.2	3.2	
S Gehärteter Stahl (40 – 52 HRC)	20	1600	670	34	4	
	6	3700	440	10	1.2	
	8	2800	440	13.5	1.6	
	10	2200	440	17	2	
	12	1900	380	20.5	2.4	
H	16	1400	340	27.2	3.2	
	20	1100	260	34	4	

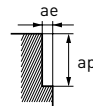

# MPMHV/W

## NUTENFRÄSEN

Material	DC	n	Vf	ap	
P C-Stahl, legierter Stahl, duktiler Gusseisen	6	6400	860	6	
	8	4800	1000	8	
	10	3800	910	10	
	12	3200	910	12	
	16	2400	690	16	
	20	1900	550	20	
	P C-Stahl, legierter Stahl, vergüteter Stahl, legierter Werkzeugstahl	6	5100	630	6
		8	3800	750	8
		10	3100	680	10
		12	2500	660	12
16		1900	500	16	
M Austenitische rostfreie Stähle, Titanlegierungen	6	4200	470	6	
	8	3200	580	8	
	10	2500	500	10	
	12	2100	500	12	
	16	1600	380	16	
S Gehärteter Stahl (40 - 52 HRC)	20	1300	310	20	
	6	1600	190	6	
	8	1200	190	8	
	10	950	150	10	
	12	800	150	12	
H	16	600	120	16	
	20	450	96	20	

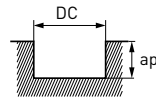

# MPMHV



## SCHAFTFRÄSER, MITTLERE SCHNEIDENLÄNGE, 4-SCHNEIDIG, VARIABLER SPIRALWINKEL

P M S H

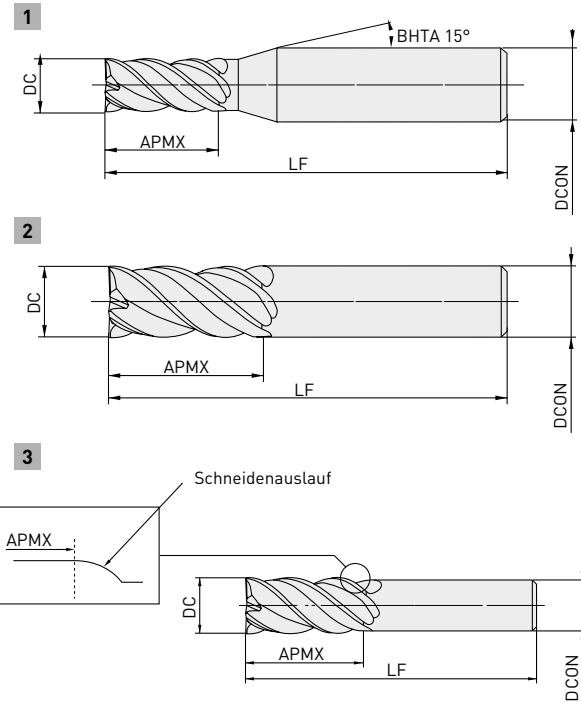

	DC ≤ 12	DC > 12			
	0	0			
	- 0.02	- 0.03			
	DCON=4	DCON=6	DCON=8		
	0	0	0		
	- 0.005	- 0.005	- 0.006		
	DCON=6 (DC=8)	DCON=8 (DC=10)	DCON=10	12 ≤ DCON ≤ 16	DCON=20
	0	0	0	0	0
	- 0.008	- 0.009	- 0.009	- 0.011	- 0.013

- 4-schneidiger Schaftfräser mit variablem Spiralwinkel zur Vibrationskontrolle bei der Bearbeitung rostfreier Stähle und C-Stähle.

Bestellnummer	Lager	DC	APMX	LF	DCON	ZEFP	Typ
MPMHVD0100	●	1	2.5	45	4	4	1
MPMHVD0150	●	1.5	3.8	45	4	4	1
MPMHVD0200	●	2	5	45	4	4	1
MPMHVD0250	●	2.5	6.3	45	4	4	1
MPMHVD0300	●	3	7.5	45	6	4	1
MPMHVD0400	●	4	10	45	6	4	1
MPMHVD0500	●	5	12.5	50	6	4	1
MPMHVD0600	●	6	15	60	6	4	2

# MPMHV

Bestellnummer	Lager	DC	APMX	LF	DCON	ZEFP	Typ
MPMHVD0700S06	●	7	17.5	80	6	4	3
MPMHVD0700	●	7	17.5	70	8	4	1
MPMHVD0800	●	8	20	70	8	4	2
MPMHVD0800S06	●	8	20	90	6	4	3
MPMHVD0900S08	●	9	22.5	90	8	4	3
MPMHVD1000	●	10	25	80	10	4	2
MPMHVD1000S08	●	10	25	100	8	4	3
MPMHVD1100S10	●	11	28	100	10	4	3
MPMHVD1200	●	12	30	100	12	4	2
MPMHVD1200S10	●	12	30	110	10	4	3
MPMHVD1300S12	●	13	32	110	12	4	3
MPMHVD1400S12	●	14	35	130	12	4	3
MPMHVD1600	●	16	40	110	16	4	2
MPMHVD1800S16	●	18	45	150	16	4	3
MPMHVD2000	●	20	50	125	20	4	2
MPMHVD2200S20	●	22	55	160	20	4	3

# MPMHV

## SCHNITTDATENEMPFEHLUNGEN

### SCHULTERFRÄSEN

Material	DC	n	Vf	ap	ae
C-Stahl, legierter Stahl, duktiler Gusseisen	1	38000	910	1.7	0.2
	1.5	27000	970	2.5	0.3
	2	21000	1500	3.5	0.4
	2.5	18000	1700	4.2	0.5
	3	16000	1800	5	0.6
	4	12000	1700	7	0.8
	5	9500	1800	8.5	1
	6	8000	2100	10	1.2
	7*	4100	1200	12	0.7
	7	6800	2000	12	1.4
	8	6000	2000	13.5	1.6
	9*	3200	1200	15	0.9
	10	4800	2100	17	2
	11	2600	1200	18.5	1.1
	12	4000	1900	20.5	2.4
	13	2200	1100	22	1.3
	14*	2000	960	24	1.4
	16	3000	1400	27.2	3.2
	18*	1600	770	31	1.8
	20	2400	1200	34	4
	22*	1300	620	37.5	2.2
	C-Stahl, legierter Stahl, vergüteter Stahl, legierter Werkzeugstahl	1	31000	500	1.7
1.5		22000	530	2.5	0.3
2		17000	820	3.5	0.4
2.5		15000	900	4.2	0.5
3		13000	940	5	0.6
4		9500	950	7	0.8
5		7600	1100	8.5	1
6		6400	1300	10	1.2
7*		3300	860	12	0.7
7		5500	1400	12	1.4
8		4800	1400	13.5	1.6
9*		2500	900	15	0.9
10		3800	1500	17	2
11		2100	880	18.5	1.1
12		3200	1400	20.5	2.4
13		1800	830	22	1.3
14*		1600	700	24	1.4
16		2400	1100	27.2	3.2
18*		1300	570	31	1.8
20		1900	840	34	4
22*		1000	440	37.5	2.2

\* Typ 3



# MPMHV

## SCHULTERFRÄSEN

Material	DC	n	Vf	ap	ae
M Austenitische rostfreie Stähle, Titanlegierungen	1	25000	500	1.7	0.2
	1.5	18000	500	2.5	0.3
	2	14000	640	3.5	0.4
	2.5	12000	820	4.2	0.5
	3	11000	880	5	0.6
	4	8000	900	7	0.8
	5	6400	900	8.5	1
	6	5300	1100	10	1.2
	7*	2700	700	12	0.7
	7	4500	1200	12	1.4
	8	4000	1200	13.5	1.6
	9*	2100	660	15	0.9
	10	3200	1100	17	2
	11	1700	520	18.5	1.1
	12	2700	1100	20.5	2.4
	13	1500	490	22	1.3
	14*	1400	460	24	1.4
	16	2000	840	27.2	3.2
	18*	1100	360	31	1.8
	20	1600	670	34	4
	22*	870	280	37.5	2.2
	S H Gehärteter Stahl (45 – 55 HRC)	1	18000	290	1.7
1.5		13000	310	2.5	0.08
2		10000	320	3.5	0.1
2.5		8500	360	4.2	0.13
3		7400	380	5	0.15
4		5600	400	7	0.2
5		4500	430	8.5	0.25
6		3700	440	10	0.3
7*		1900	270	12	0.35
7		3200	450	12	0.35
8		2800	450	13.5	0.4
9*		1500	270	15	0.45
10		2200	440	17	0.5
11		1200	190	18.5	0.55
12		1900	380	20.5	0.6
13		1000	160	22	0.65
14*		950	150	24	0.7
16		1400	340	27.2	0.8
18*		740	120	31	0.9
20		1100	260	34	1
22*		610	98	37.5	1.2

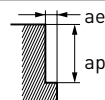

\* Typ 3

# MPMHV

## NUTENFRÄSEN

Material	DC	n	Vf	ap
C-Stahl, legierter Stahl, duktiler Gusseisen	1	31000	620	0.5
	1.5	22000	630	0.8
	2	17000	650	2
	2.5	15000	830	2.5
	3	13000	940	3
	4	9500	820	4
	5	7600	910	5
	6	6400	860	6
	7	5500	960	7
	8	4800	1000	8
	10	3800	910	10
	12	3200	920	12
	16	2400	690	16
C-Stahl, legierter Stahl, vergüteter Stahl, legierter Werkzeugstahl	20	1900	550	20
	1	24000	380	0.5
	1.5	17000	410	0.8
	2	14000	450	2
	2.5	12000	580	2.5
	3	10000	660	3
	4	7600	600	4
	5	6100	670	5
	6	5100	630	6
	7	4400	710	7
	8	3800	750	8
	10	3100	680	10
	12	2500	660	12
16	1900	500	16	
Austenitische rostfreie Stähle, Titanlegierungen	20	1500	400	20
	1	20000	400	0.5
	1.5	14000	390	0.8
	2	11000	500	2
	2.5	9700	660	2.5
	3	8500	680	3
	4	6400	720	4
	5	5100	710	5
	6	4200	870	6
	7	3600	940	7
	8	3200	960	8
	10	2500	880	10
	12	2100	860	12
16	1600	380	16	
20	1300	310	20	

# MPMHV

## NUTENFRÄSEN

Material	DC	n	Vf	ap
H Gehärteter Stahl (45 - 55 HRC)	1	9500	110	0.2
	1.5	6400	130	0.3
	2	4800	130	0.4
	2.5	3800	130	0.5
	3	3200	140	0.6
	4	2400	150	0.8
	5	1900	170	1
	6	1600	190	1.2
	7	1400	190	1.4
	8	1200	190	1.6
	10	950	150	2
	12	800	160	2.4
	16	600	120	3.2
	20	480	96	4

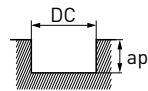

# MPJHV

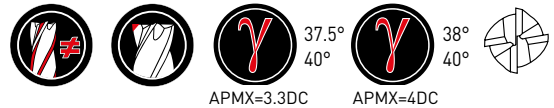

## SCHAFTFRÄSER, MITTLERE SCHNEIDENLÄNGE, 4-SCHNEIDIG, VARIABLER SPIRALWINKEL

P M S H

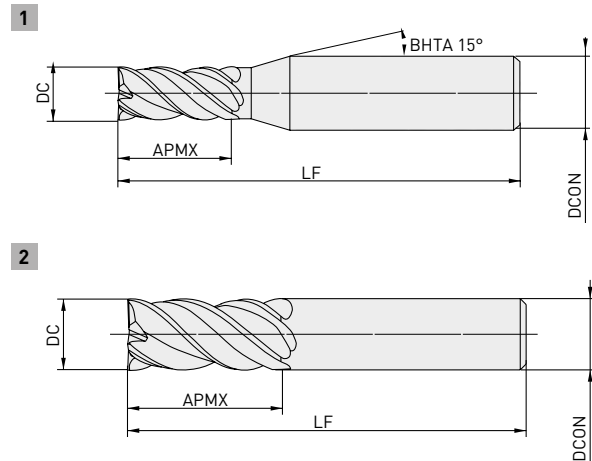

	DC ≤ 12	DC > 12		
	0 - 0.02	0 - 0.03		
	DCON=4	DCON=6	DCON=8	
	0 - 0.005	0 - 0.005	0 - 0.006	
	DCON=10	DCON=12	DCON=16	DCON=20
	0 - 0.009	0 - 0.011	0 - 0.011	0 - 0.013

- 4-schneidiger Schaftfräser mit variablem Spiralwinkel zur Vibrationskontrolle bei der Bearbeitung rostfreier Stähle und C-Stähle. Mittellange Schneidenlänge, geeignet für das Schlichten an vertikalen Wandflächen.

Bestellnummer	Lager	DC	APMX	LF	DCON	ZEFP	Typ
MPJHVD0100AP04	●	1	4	45	4	4	1
MPJHVD0150AP06	●	1.5	6	45	4	4	1
MPJHVD0200AP06	●	2	6.5	60	6	4	1
MPJHVD0200AP08	●	2	8	60	6	4	1
MPJHVD0250AP10	●	2.5	10	60	6	4	1
MPJHVD0300AP10	●	3	10	60	6	4	1
MPJHVD0300AP12	●	3	12	60	6	4	1
MPJHVD0400AP13	●	4	13	60	6	4	1
MPJHVD0400AP16	●	4	16	60	6	4	1
MPJHVD0500AP17	●	5	17	60	6	4	1
MPJHVD0500AP20	●	5	20	60	6	4	1
MPJHVD0600AP20	●	6	20	60	6	4	2
MPJHVD0600AP24	●	6	24	60	6	4	2
MPJHVD0800AP26	●	8	26	80	8	4	2
MPJHVD0800AP32	●	8	32	80	8	4	2
MPJHVD1000AP33	●	10	33	100	10	4	2
MPJHVD1000AP40	●	10	40	100	10	4	2
MPJHVD1200AP40	●	12	40	110	12	4	2
MPJHVD1200AP48	●	12	48	110	12	4	2
MPJHVD1600AP53	●	16	53	125	16	4	2
MPJHVD1600AP64	●	16	64	125	16	4	2
MPJHVD2000AP66	●	20	66	140	20	4	2
MPJHVD2000AP80	●	20	80	140	20	4	2

# MPJHV

## SCHNITTDATENEMPFEHLUNGEN

### SCHULTERFRÄSEN

Material	DC	APMX	n	Vf	ap	ae
C-Stahl, legierter Stahl, duktiler Gusseisen	1	4	19000	300	3	0.03
	1.5	6	16000	320	4.5	0.05
	2	6.5	15000	500	5	0.1
	2	8	14000	470	6	0.06
	2.5	10	13000	660	7.5	0.08
	3	10	13000	890	7.4	0.15
	3	12	12000	820	9	0.09
	4	13	9400	940	9.9	0.2
	4	16	9000	900	12	0.12
	5	17	7500	990	12.4	0.25
	5	20	7200	950	15	0.15
	6	20	6300	1100	14.9	0.3
	6	24	6000	1000	18	0.18
	8	26	4700	1100	19.8	0.4
	8	32	4500	1000	24	0.24
	10	33	3800	1000	24.8	0.5
	10	40	3600	970	30	0.3
	12	40	3100	1000	29.7	0.6
	12	48	3000	970	36	0.36
	16	53	2400	780	27.2	0.48
16	64	2200	710	48	0.48	
20	66	1900	620	34	0.6	
20	80	1800	580	60	0.6	
C-Stahl, legierter Stahl, vergüteter Stahl, legierter Werkzeugstahl	1	4	15000	240	3	0.03
	1.5	6	13000	260	4.5	0.05
	2	6.5	12000	380	5	0.1
	2	8	11000	350	6	0.06
	2.5	10	11000	520	7.5	0.08
	3	10	10000	620	7.4	0.15
	3	12	9500	590	9	0.09
	4	13	7500	650	9.9	0.2
	4	16	7200	620	12	0.12
	5	17	6000	680	12.4	0.25
	5	20	5700	650	15	0.15
	6	20	5000	760	14.9	0.3
	6	24	4800	730	18	0.18
	8	26	3800	800	19.8	0.4
	8	32	3600	760	24	0.24
	10	33	3000	760	24.8	0.5
	10	40	2900	730	30	0.3
	12	40	2500	720	29.7	0.6
	12	48	2400	690	36	0.36
	16	53	1900	550	39.6	0.8
16	64	1800	520	48	0.48	
20	66	1500	430	49.5	1	
20	80	1400	400	60	0.6	

# MPJHV

## SCHULTERFRÄSEN

Material	DC	APMX	n	Vf	ap	ae
M Austenitische rostfreie Stähle, Titanlegierungen	1	4	13000	210	3	0.03
	1.5	6	11000	220	4.5	0.05
	2	6.5	10000	320	5	0.1
	2	8	9500	300	6	0.06
	2.5	10	8900	390	7.5	0.08
	3	10	8400	470	7.4	0.15
	3	12	8000	450	9	0.09
	4	13	6300	530	9.9	0.2
	4	16	6000	500	12	0.12
	5	17	5000	560	12.4	0.25
	5	20	4800	540	15	0.15
	6	20	4200	640	14.9	0.3
	6	24	4000	610	18	0.18
	8	26	3.100	620	19.8	0.4
	8	32	3000	600	24	0.24
	10	33	2500	590	24.8	0.5
	10	40	2400	570	30	0.3
	12	40	2100	550	29.7	0.6
	12	48	2000	520	36	0.36
	16	53	1600	420	39.6	0.8
	16	64	1500	390	48	0.48
	20	66	1300	340	49.5	1
20	80	1200	310	60	0.6	
H Gehärteter Stahl (45 – 55 HRC)	1	4	13000	160	3	0.02
	1.5	6	8500	170	4.5	0.03
	2	6.5	7700	220	5	0.06
	2	8	7300	200	6	0.04
	2.5	10	6300	250	7.5	0.05
	3	10	5900	300	7.4	0.09
	3	12	5600	280	9	0.06
	4	13	4700	320	9.9	0.12
	4	16	4500	310	12	0.08
	5	17	3800	350	12.4	0.15
	5	20	3600	330	15	0.1
	6	20	3200	350	14.9	0.18
	6	24	3000	330	18	0.12
	8	26	2400	360	19.8	0.24
	8	32	2300	350	24	0.16
	10	33	1900	330	24.8	0.3
	10	40	1800	310	30	0.2
	12	40	1600	300	29.7	0.36
	12	48	1500	280	36	0.24
	16	53	1200	240	39.6	0.48
	16	64	1100	220	48	0.32
	20	66	950	190	49.5	0.6
20	80	900	180	60	0.4	

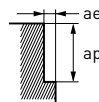

# MP2SSB

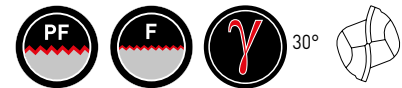

## KUGELKOPFFRÄSER, KURZE SCHNITTLÄNGE, 2-SCHNEIDIG, KURZER SCHAFT

P M N S H

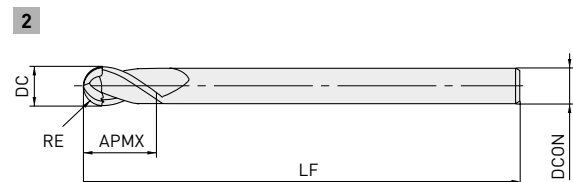
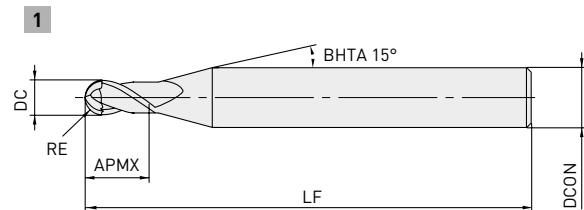

	0.1 < RE < 6		
	±0.005		
	4 < DCON < 6	8 < DCON < 10	DCON = 12
	0	0	0
	-0.005	-0.006	-0.008

- 2-schneidiger Kugelkopffräser mit kurzer Schneidenlänge für allgemeine Anwendungen. Ausgezeichnete Leistung beim Fräsen einer Vielzahl von Werkstückmaterialien wie C-Stahl, legierter Stahl und gehärteter Stahl.

Bestellnummer	Lager	RE	DC	APMX	LF	DCON	ZEFP	Typ
MP2SSBR0010	●	0.1	0.2	0.2	40	4	2	1
MP2SSBR0020	●	0.2	0.4	0.4	40	4	2	1
MP2SSBR0030	●	0.3	0.6	0.6	40	4	2	1
MP2SSBR0040	●	0.4	0.8	0.8	40	4	2	1
MP2SSBR0050	●	0.5	1	1	40	4	2	1
MP2SSBR0050S06	●	0.5	1	1	40	6	2	1
MP2SSBR0075	●	0.75	1.5	1.5	40	4	2	1
MP2SSBR0075S06	●	0.75	1.5	1.5	40	6	2	1
MP2SSBR0100	●	1	2	2	45	6	2	1
MP2SSBR0150	●	1.5	3	3	45	6	2	1
MP2SSBR0200	●	2	4	4	45	6	2	1
MP2SSBR0250	●	2.5	5	5	50	6	2	1
MP2SSBR0300	●	3	6	6	50	6	2	2
MP2SSBR0400	●	4	8	8	60	8	2	2
MP2SSBR0500	●	5	10	10	70	10	2	2
MP2SSBR0600	●	6	12	12	75	12	2	2

# MP2SSB

## SCHNITTDATENEMPFEHLUNGEN

### 3D FRÄSEN

Material	RE	$\alpha < 15^\circ$		$\alpha > 15^\circ$		ap	ae
		n	Vf	n	Vf		
P Baustahl, C-Stahl, legierter Stahl, vergüteter Stahl, gehärteter Stahl (- 45 HRC)	R 0.1	40000	300	40000	250	0.003	0.02
	R 0.15	40000	500	40000	350	0.007	0.03
	R 0.2	40000	1600	40000	1200	0.02	0.04
	R 0.25	40000	2400	40000	1400	0.025	0.05
	R 0.3	40000	3200	40000	1600	0.03	0.06
	R 0.4	40000	4800	40000	2400	0.05	0.08
	R 0.5	40000	5600	40000	3200	0.06	0.1
	R 0.75	40000	6500	40000	4000	0.09	0.15
	R 1	40000	6500	39000	4700	0.11	0.2
	R 1.25	40000	7000	33000	4500	0.12	0.25
	R 1.5	40000	7500	27000	4300	0.13	0.3
	R 2	32000	7500	20000	3600	0.15	0.4
	R 2.5	25000	6000	16000	2900	0.2	0.5
	R 3	21000	5800	13000	2600	0.25	0.6
	R 4	16000	4500	10000	2000	0.3	0.8
	R 5	13000	3600	8000	1700	0.5	1.0
	R 6	9000	2500	6000	1300	0.5	1.2
M Austenitische rostfreie Stähle, Titanlegierungen	R 0.1	40000	300	40000	250	0.003	0.02
	R 0.15	40000	500	40000	350	0.007	0.03
	R 0.2	40000	1500	40000	1000	0.02	0.04
	R 0.25	40000	2100	40000	1200	0.025	0.05
	R 0.3	40000	2800	40000	1400	0.03	0.06
	R 0.4	40000	4600	40000	2100	0.05	0.08
	R 0.5	40000	5600	40000	3400	0.06	0.1
	R 0.75	40000	6500	36000	3600	0.09	0.15
	R 1	40000	6500	35000	4000	0.11	0.2
	R 1.25	40000	7400	29000	4000	0.12	0.25
	R 1.5	36000	6900	24000	3900	0.13	0.3
	R 2	28000	6900	18000	3100	0.15	0.4
	R 2.5	22000	6200	14000	2600	0.2	0.5
	R 3	18000	5400	11000	2300	0.25	0.6
	R 4	14000	4100	9000	1700	0.3	0.8
	R 5	11000	3300	7200	1300	0.5	1.0
	R 6	8100	2300	5400	1100	0.5	1.2



# MP2SSB

Material	RE	$\alpha < 15^\circ$		$\alpha > 15^\circ$		ap	ae
		n	Vf	n	Vf		
N Kupfer, Kupferlegierungen	R 0.1	40000	300	40000	250	0.003	0.02
	R 0.15	40000	500	40000	350	0.007	0.03
	R 0.2	40000	1300	40000	950	0.015	0.04
	R 0.25	40000	1900	40000	1100	0.02	0.05
	R 0.3	40000	2500	40000	1300	0.025	0.06
	R 0.4	40000	4000	40000	1900	0.04	0.08
	R 0.5	40000	5600	40000	3000	0.05	0.1
	R 0.75	40000	6500	32000	3200	0.08	0.15
	R 1	40000	6500	31000	3500	0.11	0.2
	R 1.25	36000	6500	26000	3500	0.12	0.25
	R 1.5	32000	6000	22000	3400	0.13	0.3
	R 2	25000	6000	16000	2700	0.15	0.6
	R 2.5	20000	5400	13000	2300	0.2	0.75
	R 3	17000	4700	10000	2000	0.25	0.9
	R 4	13000	3600	8000	1500	0.3	1.6
	R 5	10000	2900	6400	1200	0.5	2.0
	R 6	8500	2300	5300	1100	0.5	2.4
	H Gehärteter Stahl (45-55 HRC)	R 0.1	40000	300	40000	250	0.003
R 0.15		40000	500	40000	350	0.007	0.03
R 0.2		40000	1300	40000	950	0.015	0.04
R 0.25		40000	1900	40000	1100	0.02	0.05
R 0.3		40000	2500	40000	1300	0.025	0.06
R 0.4		40000	4000	40000	1900	0.04	0.08
R 0.5		40000	5600	40000	3000	0.05	0.1
R 0.75		40000	6500	32000	3200	0.08	0.15
R 1		40000	6500	31000	3500	0.11	0.2
R 1.25		36000	6500	26000	3500	0.12	0.25
R 1.5		32000	6000	22000	3400	0.13	0.3
R 2		25000	6000	16000	2700	0.15	0.4
R 2.5		20000	5400	13000	2300	0.2	0.5
R 3		17000	4700	10000	2000	0.25	0.6
R 4		13000	3600	8000	1500	0.3	0.8
R 5		10000	2900	6400	1200	0.5	1.0
R 6		7200	2000	4800	1000	0.5	1.2

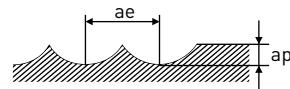

1.  $\alpha$  ist der Anstellwinkel zur Bearbeitungsfläche.
2. Bei geringen Schnitttiefen können Drehzahl und Vorschub erhöht werden.
3. Falls die Stabilität der Maschine oder der Werkstückbefestigung sehr gering ist oder Vibrationen auftreten, müssen Drehzahl und Vorschub entsprechend reduziert werden, oder es muss eine geringere Schnitttiefe eingestellt werden.
4. Standard-Schnittbedingungen für austenitischen rostfreien Stahl und Titanlegierungen, reduzieren Sie jedoch die Spindeldrehzahl auf 60 % und die Vorschubgeschwindigkeit auf 45 %.

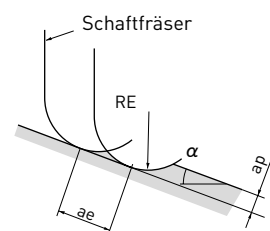

# MP2SB



## KUGELKOPFFRÄSER, KURZE SCHNITTLÄNGE, 2-SCHNEIDIG



$0.1 < RE < 6$

$\pm 0.005$



$4 < DCON < 6$	$8 < DCON < 10$	$DCON = 12$
0	0	0
-0.005	-0.006	-0.008

0

0

0

-0.005

-0.006

-0.008

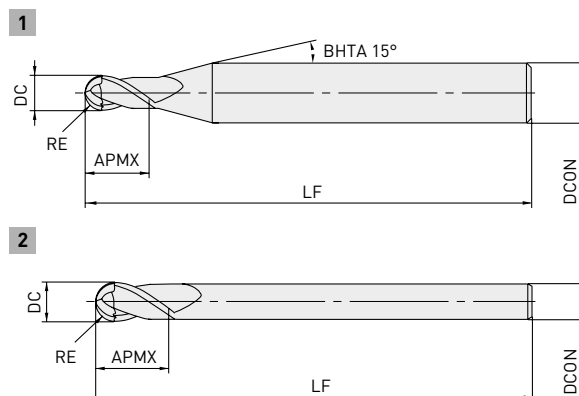

- 2-schneidiger Kugelkopffräser mit kurzer Schneidenlänge für allgemeine Anwendungen. Ausgezeichnete Leistung beim Fräsen einer Vielzahl von Werkstückmaterialien wie C-Stahl, legierter Stahl und gehärteter Stahl.

Bestellnummer	Lager	RE	DC	APMX	LF	DCON	ZEFP	Typ
MP2SBR0010	●	0.1	0.2	0.3	45	4	2	1
MP2SBR0015	●	0.15	0.3	0.5	45	4	2	1
MP2SBR0020	●	0.2	0.4	0.6	45	4	2	1
MP2SBR0020S06	●	0.2	0.4	0.6	50	6	2	1
MP2SBR0025	●	0.25	0.5	0.8	45	4	2	1
MP2SBR0030	●	0.3	0.6	0.9	45	4	2	1
MP2SBR0030S06	●	0.3	0.6	0.9	50	6	2	1
MP2SBR0035	●	0.35	0.7	1.1	45	4	2	1
MP2SBR0040	●	0.4	0.8	1.2	45	4	2	1
MP2SBR0040S06	●	0.4	0.8	1.2	50	6	2	1
MP2SBR0045	●	0.45	0.9	1.4	45	4	2	1
MP2SBR0050	●	0.5	1	1.5	45	4	2	1
MP2SBR0050S06	●	0.5	1	1.5	50	6	2	1
MP2SBR0060	●	0.6	1.2	1.8	45	4	2	1
MP2SBR0070	●	0.7	1.4	2.1	45	4	2	1
MP2SBR0075	●	0.75	1.5	2.3	45	4	2	1
MP2SBR0075S06	●	0.75	1.5	2.3	50	6	2	1
MP2SBR0080	●	0.8	1.6	2.4	45	4	2	1
MP2SBR0090	●	0.9	1.8	2.7	45	4	2	1
MP2SBR0100	●	1	2	3	50	4	2	1
MP2SBR0100S06	●	1	2	3	50	6	2	1
MP2SBR0125	●	1.25	2.5	3.8	50	4	2	1
MP2SBR0150	●	1.5	3	4.5	70	6	2	1
MP2SBR0200	●	2	4	6	70	6	2	1
MP2SBR0250	●	2.5	5	7.5	80	6	2	1
MP2SBR0300	●	3	6	9	80	6	2	2
MP2SBR0400	●	4	8	12	90	8	2	2
MP2SBR0500	●	5	10	15	100	10	2	2
MP2SBR0600	●	6	12	18	110	12	2	2

# MP2SB

## SCHNITTDATENEMPFEHLUNGEN

### 3D FRÄSEN

Material	RE	$\alpha < 15^\circ$		$\alpha > 15^\circ$		ap	ae
		n	Vf	n	Vf		
P Baustahl, C-Stahl, legierter Stahl, vergüteter Stahl, gehärteter Stahl (- 45 HRC)	R 0.1	40000	300	40000	250	0.003	0.02
	R 0.15	40000	500	40000	350	0.007	0.03
	R 0.2	40000	1600	40000	1200	0.02	0.04
	R 0.25	40000	2400	40000	1400	0.025	0.05
	R 0.3	40000	3200	40000	1600	0.03	0.06
	R 0.4	40000	4800	40000	2400	0.05	0.08
	R 0.5	40000	5600	40000	3200	0.06	0.1
	R 0.75	40000	6500	40000	4000	0.09	0.15
	R 1	40000	6500	39000	4700	0.11	0.2
	R 1.25	40000	7000	33000	4500	0.12	0.25
	R 1.5	40000	7500	27000	4300	0.13	0.3
	R 2	32000	7500	20000	3600	0.15	0.4
	R 2.5	25000	6000	16000	2900	0.2	0.5
	R 3	21000	5800	13000	2600	0.25	0.6
	R 4	16000	4500	10000	2000	0.3	0.8
	R 5	13000	3600	8000	1700	0.5	1.0
	R 6	9000	2500	6000	1300	0.5	1.2
M Austenitische rostfreie Stähle, Titanlegierungen	R 0.1	40000	300	40000	250	0.003	0.02
	R 0.15	40000	500	40000	350	0.007	0.03
	R 0.2	40000	1500	40000	1000	0.02	0.04
	R 0.25	40000	2100	40000	1200	0.025	0.05
	R 0.3	40000	2800	40000	1400	0.03	0.06
	R 0.4	40000	4600	40000	2100	0.05	0.08
	R 0.5	40000	5600	40000	3400	0.06	0.1
	R 0.75	40000	6500	36000	3600	0.09	0.15
	R 1	40000	6500	35000	4000	0.11	0.2
	R 1.25	40000	7400	29000	4000	0.12	0.25
	R 1.5	36000	6900	24000	3900	0.13	0.3
	R 2	28000	6900	18000	3100	0.15	0.4
	R 2.5	22000	6200	14000	2600	0.2	0.5
	R 3	18000	5400	11000	2300	0.25	0.6
	R 4	14000	4100	9000	1700	0.3	0.8
	R 5	11000	3300	7200	1300	0.5	1.0
	R 6	8100	2300	5400	1100	0.5	1.2

# MP2SB

Material	RE	$\alpha < 15^\circ$		$\alpha > 15^\circ$		ap	ae
		n	Vf	n	Vf		
N Kupfer, Kupferlegierungen	R 0.1	40000	300	40000	250	0.003	0.02
	R 0.15	40000	500	40000	350	0.007	0.03
	R 0.2	40000	1300	40000	950	0.015	0.04
	R 0.25	40000	1900	40000	1100	0.02	0.05
	R 0.3	40000	2500	40000	1300	0.025	0.06
	R 0.4	40000	4000	40000	1900	0.04	0.08
	R 0.5	40000	5600	40000	3000	0.05	0.1
	R 0.75	40000	6500	32000	3200	0.08	0.15
	R 1	40000	6500	31000	3500	0.11	0.2
	R 1.25	36000	6500	26000	3500	0.12	0.25
	R 1.5	32000	6000	22000	3400	0.13	0.3
	R 2	25000	6000	16000	2700	0.15	0.6
	R 2.5	20000	5400	13000	2300	0.2	0.75
	R 3	17000	4700	10000	2000	0.25	0.9
	R 4	13000	3600	8000	1500	0.3	1.6
	R 5	10000	2900	6400	1200	0.5	2.0
	R 6	8500	2300	5300	1100	0.5	2.4
	H Gehärteter Stahl (45-55 HRC)	R 0.1	40000	300	40000	250	0.003
R 0.15		40000	500	40000	350	0.007	0.03
R 0.2		40000	1300	40000	950	0.015	0.04
R 0.25		40000	1900	40000	1100	0.02	0.05
R 0.3		40000	2500	40000	1300	0.025	0.06
R 0.4		40000	4000	40000	1900	0.04	0.08
R 0.5		40000	5600	40000	3000	0.05	0.1
R 0.75		40000	6500	32000	3200	0.08	0.15
R 1		40000	6500	31000	3500	0.11	0.2
R 1.25		36000	6500	26000	3500	0.12	0.25
R 1.5		32000	6000	22000	3400	0.13	0.3
R 2		25000	6000	16000	2700	0.15	0.4
R 2.5		20000	5400	13000	2300	0.2	0.5
R 3		17000	4700	10000	2000	0.25	0.6
R 4		13000	3600	8000	1500	0.3	0.8
R 5		10000	2900	6400	1200	0.5	1.0
R 6		7200	2000	4800	1000	0.5	1.2

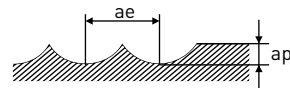

1.  $\alpha$  ist der Anstellwinkel zur Bearbeitungsfläche.
2. Bei geringen Schnitttiefen können Drehzahl und Vorschub erhöht werden.
3. Falls die Stabilität der Maschine oder der Werkstückbefestigung sehr gering ist oder Vibrationen auftreten, müssen Drehzahl und Vorschub entsprechend reduziert werden, oder es muss eine geringere Schnitttiefe eingestellt werden.
4. Standard-Schnittbedingungen für austenitischen rostfreien Stahl und Titanlegierungen, reduzieren Sie jedoch die Spindeldrehzahl auf 60 % und die Vorschubgeschwindigkeit auf 45 %.

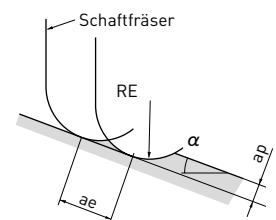

# MP2MB

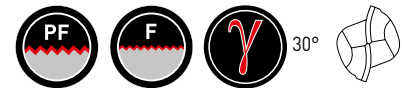

## KUGELKOPFFRÄSER, MITTLERE SCHNEIDENLÄNGE, 2-SCHNEIDIG



$0.25 < RE < 6$

$\pm 0.005$



$4 < DCON < 6$     $8 < DCON < 10$     $DCON = 12$

0   0   0  
-0.005   -0.006   -0.008

1

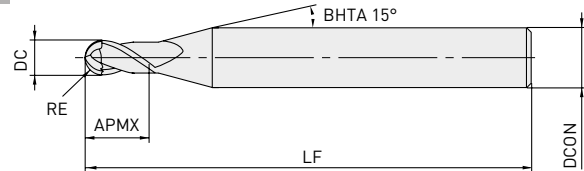

2

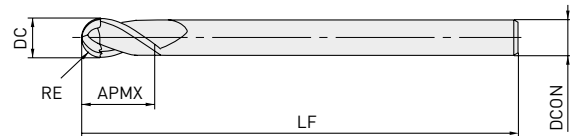

- 2-schneidiger Kugelkopffräser mit mittlerer Schneidenlänge für die allgemeine Bearbeitung. Ausgezeichnete Leistung beim Fräsen einer Vielzahl von Werkstückmaterialien wie C-Stahl, legierter Stahl und gehärteter Stahl.

Bestellnummer	Lager	RE	DC	APMX	LF	DCON	ZEFP	Typ
MP2MBR0025	●	0.25	0.5	1	45	4	2	1
MP2MBR0030	●	0.3	0.6	1.2	45	4	2	1
MP2MBR0040	●	0.4	0.8	1.6	45	4	2	1
MP2MBR0050	●	0.5	1	2.5	45	4	2	1
MP2MBR0060	●	0.6	1.2	2.5	45	4	2	1
MP2MBR0070	●	0.7	1.4	3	45	4	2	1
MP2MBR0075	●	0.75	1.5	4	45	4	2	1
MP2MBR0080	●	0.8	1.6	4	45	4	2	1
MP2MBR0090	●	0.9	1.8	5	45	4	2	1
MP2MBR0100	●	1	2	6	50	4	2	1
MP2MBR0125	●	1.25	2.5	6	50	4	2	1
MP2MBR0150S03	●	1.5	3	8	70	3	2	2
MP2MBR0150	●	1.5	3	8	70	6	2	1
MP2MBR0175	●	1.75	3.5	8	70	6	2	1
MP2MBR0200S04	●	2	4	8	70	4	2	2
MP2MBR0200	●	2	4	8	70	6	2	1
MP2MBR0250	●	2.5	5	12	80	6	2	1
MP2MBR0300	●	3	6	12	80	6	2	2
MP2MBR0400	●	4	8	14	90	8	2	2
MP2MBR0500	●	5	10	18	100	10	2	2
MP2MBR0600	●	6	12	22	110	12	2	2

# MP2MB

## SCHNITTDATENEMPFEHLUNGEN

### 3D FRÄSEN

Material	RE	$\alpha < 15^\circ$		$\alpha > 15^\circ$		ap	ae
		n	Vf	n	Vf		
P Baustahl, C-Stahl, legierter Stahl, vergüteter Stahl, gehärteter Stahl (- 45 HRC)	R 0.1	40000	300	40000	250	0.003	0.02
	R 0.15	40000	500	40000	350	0.007	0.03
	R 0.2	40000	1600	40000	1200	0.02	0.04
	R 0.25	40000	2400	40000	1400	0.025	0.05
	R 0.3	40000	3200	40000	1600	0.03	0.06
	R 0.4	40000	4800	40000	2400	0.05	0.08
	R 0.5	40000	5600	40000	3200	0.06	0.1
	R 0.75	40000	6500	40000	4000	0.09	0.15
	R 1	40000	6500	39000	4700	0.11	0.2
	R 1.25	40000	7000	33000	4500	0.12	0.25
	R 1.5	40000	7500	27000	4300	0.13	0.3
	R 2	32000	7500	20000	3600	0.15	0.4
	R 2.5	25000	6000	16000	2900	0.2	0.5
	R 3	21000	5800	13000	2600	0.25	0.6
	R 4	16000	4500	10000	2000	0.3	0.8
	R 5	13000	3600	8000	1700	0.5	1.0
	R 6	9000	2500	6000	1300	0.5	1.2
	M Austenitische rostfreie Stähle, Titanlegierungen	R 0.1	40000	300	40000	250	0.003
R 0.15		40000	500	40000	350	0.007	0.03
R 0.2		40000	1500	40000	1000	0.02	0.04
R 0.25		40000	2100	40000	1200	0.025	0.05
R 0.3		40000	2800	40000	1400	0.03	0.06
R 0.4		40000	4600	40000	2100	0.05	0.08
R 0.5		40000	5600	40000	3400	0.06	0.1
R 0.75		40000	6500	36000	3600	0.09	0.15
R 1		40000	6500	35000	4000	0.11	0.2
R 1.25		40000	7400	29000	4000	0.12	0.25
R 1.5		36000	6900	24000	3900	0.13	0.3
R 2		28000	6900	18000	3100	0.15	0.4
R 2.5		22000	6200	14000	2600	0.2	0.5
R 3		18000	5400	11000	2300	0.25	0.6
R 4		14000	4100	9000	1700	0.3	0.8
R 5		11000	3300	7200	1300	0.5	1.0
R 6		8100	2300	5400	1100	0.5	1.2

# MP2MB

Material	RE	$\alpha < 15^\circ$		$\alpha > 15^\circ$		ap	ae
		n	Vf	n	Vf		
N Kupfer, Kupferlegierungen	R 0.1	40000	300	40000	250	0.003	0.02
	R 0.15	40000	500	40000	350	0.007	0.03
	R 0.2	40000	1300	40000	950	0.015	0.04
	R 0.25	40000	1900	40000	1100	0.02	0.05
	R 0.3	40000	2500	40000	1300	0.025	0.06
	R 0.4	40000	4000	40000	1900	0.04	0.08
	R 0.5	40000	5600	40000	3000	0.05	0.1
	R 0.75	40000	6500	32000	3200	0.08	0.15
	R 1	40000	6500	31000	3500	0.11	0.2
	R 1.25	36000	6500	26000	3500	0.12	0.25
	R 1.5	32000	6000	22000	3400	0.13	0.3
	R 2	25000	6000	16000	2700	0.15	0.6
	R 2.5	20000	5400	13000	2300	0.2	0.75
	R 3	17000	4700	10000	2000	0.25	0.9
	R 4	13000	3600	8000	1500	0.3	1.6
	R 5	10000	2900	6400	1200	0.5	2.0
	R 6	8500	2300	5300	1100	0.5	2.4
H Gehärteter Stahl (45-55 HRC)	R 0.1	40000	300	40000	250	0.003	0.02
	R 0.15	40000	500	40000	350	0.007	0.03
	R 0.2	40000	1300	40000	950	0.015	0.04
	R 0.25	40000	1900	40000	1100	0.02	0.05
	R 0.3	40000	2500	40000	1300	0.025	0.06
	R 0.4	40000	4000	40000	1900	0.04	0.08
	R 0.5	40000	5600	40000	3000	0.05	0.1
	R 0.75	40000	6500	32000	3200	0.08	0.15
	R 1	40000	6500	31000	3500	0.11	0.2
	R 1.25	36000	6500	26000	3500	0.12	0.25
	R 1.5	32000	6000	22000	3400	0.13	0.3
	R 2	25000	6000	16000	2700	0.15	0.4
	R 2.5	20000	5400	13000	2300	0.2	0.5
	R 3	17000	4700	10000	2000	0.25	0.6
	R 4	13000	3600	8000	1500	0.3	0.8
	R 5	10000	2900	6400	1200	0.5	1.0
	R 6	7200	2000	4800	1000	0.5	1.2

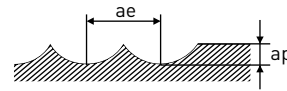

1.  $\alpha$  ist der Anstellwinkel zur Bearbeitungsfläche.
2. Bei geringen Schnitttiefen können Drehzahl und Vorschub erhöht werden.
3. Falls die Stabilität der Maschine oder der Werkstückbefestigung sehr gering ist oder Vibrationen auftreten, müssen Drehzahl und Vorschub entsprechend reduziert werden, oder es muss eine geringere Schnitttiefe eingestellt werden.
4. Standard-Schnittbedingungen für austenitischen rostfreien Stahl und Titanlegierungen, reduzieren Sie jedoch die Spindeldrehzahl auf 60 % und die Vorschubgeschwindigkeit auf 45 %.

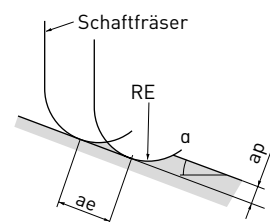

# MP2SDB



## KUGELKOPFFRÄSER, KURZE SCHNEIDENLÄNGE, 2-SCHNEIDIG, HOCHSTABILE GEOMETRIE

P H



1

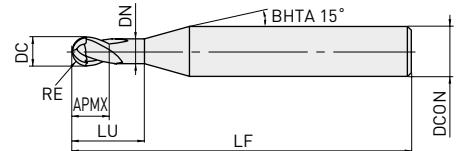

2

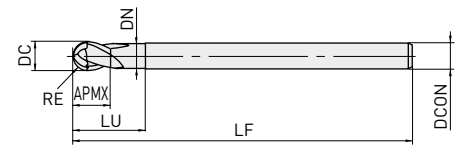

	0.1 < RE < 6	
	±0.01	
	4 < DCON < 6	DCON = 8
	0 -0.005	0 -0.006
	DCON = 10	DCON = 12
	0 -0.009	0 -0.011

- Hervorragende Bruchfestigkeit mit einer stabilen S-Bogen-Schneidkante.
- Ideal zum Vorschlichten von Gesenken.

Bestellnummer	Lager	RE	DC	APMX	LU	DN	LF	DCON	ZEFP	Typ
MP2SDBR0050	●	0.5	1	1	2	0.96	50	4	2	1
MP2SDBR0075S06	●	0.75	1.5	1.5	3	1.46	50	6	2	1
MP2SDBR0100	●	1	2	2	4	1.90	50	4	2	1
MP2SDBR0100S06	●	1	2	2	4	1.90	60	6	2	1
MP2SDBR0150	●	1.5	3	3	6	2.90	70	4	2	1
MP2SDBR0200	●	2	4	4	8	3.90	60	4	2	2
MP2SDBR0200S06	●	2	4	4	8	3.90	70	6	2	1
MP2SDBR0250	●	2.5	5	5	10	4.90	80	6	2	1
MP2SDBR0300	●	3	6	12	18	5.85	80	6	2	2
MP2SDBR0300A120	●	3	6	12	18	5.85	120	6	2	2
MP2SDBR0400	●	4	8	14	24	7.85	90	8	2	2
MP2SDBR0400A130	●	4	8	14	24	7.85	130	8	2	2
MP2SDBR0500	●	5	10	18	30	9.70	100	10	2	2
MP2SDBR0500A140	●	5	10	18	30	9.70	140	10	2	2
MP2SDBR0600	●	6	12	22	36	11.70	110	12	2	2
MP2SDBR0600A140	●	6	12	22	36	11.70	140	12	2	2



# MP2SDB

## SCHNITTDATENEMPFEHLUNGEN

### AUSKRAGUNG UNTER 5D (D:DURCHM.)

Material	RE	$\alpha < 15^\circ$		$\alpha > 15^\circ$		ap	ae
		n	Vf	n	Vf		
P C-Stahl, legierter Stahl, Legierter Werkzeugstahl, Werkzeugstahl, Vergüteter Stahl	R 0.5	40000	3900	36000	2100	0.1	0.25
	R 0.75	40000	4200	36000	2600	0.15	0.35
	R 1	40000	4500	36000	3100	0.2	0.5
	R 1.5	37000	5300	24000	2700	0.3	0.75
	R 2x4	24000	3200	15000	2000	0.25	0.7
	R 2	30000	4900	19000	2500	0.4	1
	R 2.5	25000	4500	16000	2300	0.5	1.3
	R 3	22000	4300	14000	2200	0.6	1.8
	R 4	19000	3900	12000	2000	0.8	2.4
	R 5	15000	3300	9500	1800	1	3
	R 6	12000	2550	8000	1600	1.2	3.6
	H Gehärteter Stahl (45-55 HRC)	R 0.5	40000	4300	36000	2200	0.1
R 0.75		40000	4700	36000	2700	0.15	0.35
R 1		40000	5000	36000	3300	0.2	0.5
R 1.5		37000	5800	24000	2800	0.3	0.75
R 2x4		19000	2800	13000	1600	0.25	0.7
R 2		28000	5000	19000	2400	0.4	1
R 2.5		22000	4200	16000	2200	0.5	1.25
R 3		18000	3800	12000	1800	0.6	1.5
R 4		15000	3200	9500	1600	0.8	2
R 5		11000	2500	7000	1400	1	2.5
R 6		9000	2000	6000	1300	1.2	3

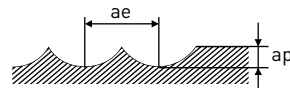

# MP2SDB

## AUSKRAGUNG UNTER 7D (D:DURCHM.)

Material	RE	$\alpha < 15^\circ$		$\alpha > 15^\circ$		ap	ae
		n	Vf	n	Vf		
P C-Stahl, legierter Stahl, Legierter Werkzeugstahl, Werkzeugstahl, Vergüteter Stahl	R 3	10000	1500	6900	1000	0.2	1
	R 4	8000	1400	5600	900	0.3	1.5
	R 5	6000	1200	4100	740	0.4	2
	R 6	5000	1000	3400	600	0.45	2.4
H Gehärteter Stahl (45-55 HRC)	R 3	8000	1400	5300	770	0.2	0.8
	R 4	6400	1300	4000	650	0.3	1.2
	R 5	4800	1100	3200	580	0.4	1.6
	R 6	4000	900	2700	490	0.45	2

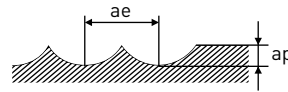

1.  $\alpha$  ist der Anstellwinkel zur Bearbeitungsfläche.
2. Bei geringeren Schnitttiefen als in dieser Tabelle angegeben können Drehzahl und Vorschub erhöht werden.
3. Falls die Stabilität der Maschine oder der Werkstückbefestigung sehr gering ist oder Vibrationen auftreten, müssen Drehzahl und Vorschub entsprechend reduziert werden, oder es muss eine geringere Schnitttiefe eingestellt werden.

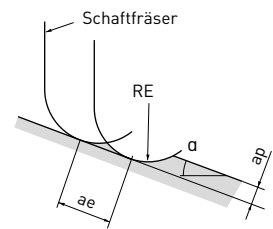

# MP2XLB

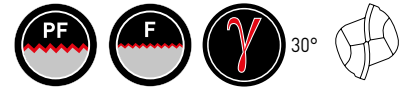

## KUGELKOPFFRÄSER, KURZE SCHNEIDENLÄNGE, 2-SCHNEIDIG, LANGER HINTERSCHLIFF

P N H

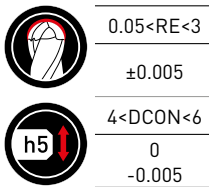

0.05 < RE < 3  
±0.005  
4 < DCON < 6  
0  
-0.005

Effektive Länge  
bei Neigungswinkel

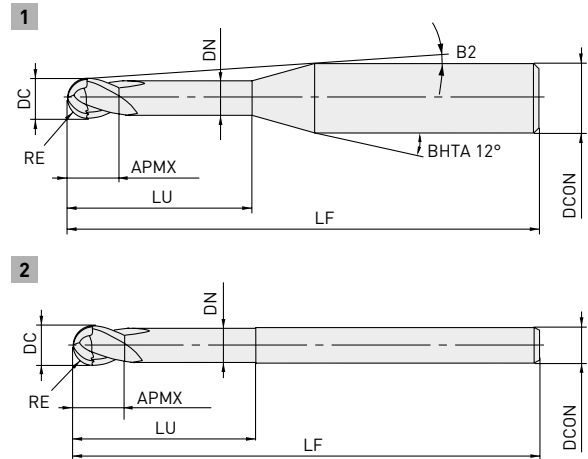
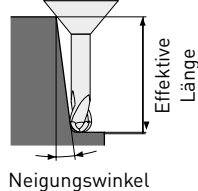

- 2-schneidiger Kugelkopffräser mit langem Hinterschliff. Ausgezeichnete Leistung beim Fräsen einer Vielzahl von Werkstückmaterialien wie C-Stahl, legierter Stahl und gehärteter Stahl.

Bestellnummer	Lager	RE	DC	APMX	LU	DN	B2	LF	DCON	ZEFP	Typ	Effektive Länge bei Neigungswinkel			
												30°	1°	2°	3°
MP2XLB R0005N003	●	0.05	0.1	0.08	0.3	0.085	11.6°	50	4	2	1	0.3	0.3	0.4	0.4
MP2XLB R0005N005	●	0.05	0.1	0.08	0.5	0.085	11.4°	50	4	2	1	0.5	0.5	0.6	0.7
MP2XLB R0010N005	●	0.1	0.2	0.15	0.5	0.18	11.5°	50	4	2	1	0.5	0.5	0.6	0.7
MP2XLB R0010N008	●	0.1	0.2	0.15	0.75	0.18	11.2°	50	4	2	1	0.8	0.8	0.9	1.0
MP2XLB R0010N010	●	0.1	0.2	0.15	1	0.18	10.9°	50	4	2	1	1.0	1.1	1.2	1.3
MP2XLB R0010N013	●	0.1	0.2	0.15	1.25	0.18	10.6°	50	4	2	1	1.3	1.4	1.5	1.7
MP2XLB R0010N015	●	0.1	0.2	0.15	1.5	0.18	10.4°	50	4	2	1	1.6	1.6	1.8	2.0
MP2XLB R0010N018	●	0.1	0.2	0.15	1.75	0.18	10.2°	50	4	2	1	1.8	1.9	2.1	2.3
MP2XLB R0010N020	●	0.1	0.2	0.15	2	0.18	9.9°	50	4	2	1	2.1	2.2	2.4	2.6
MP2XLB R0010N025	●	0.1	0.2	0.15	2.5	0.18	9.5°	50	4	2	1	2.6	2.7	3.0	3.3
MP2XLB R0015N005	●	0.15	0.3	0.24	0.5	0.28	11.5°	50	4	2	1	0.5	0.5	0.6	0.6
MP2XLB R0015N008	●	0.15	0.3	0.24	0.75	0.28	11.2°	50	4	2	1	0.8	0.8	0.9	1.0
MP2XLB R0015N010	●	0.15	0.3	0.24	1	0.28	10.9°	50	4	2	1	1.0	1.1	1.2	1.3
MP2XLB R0015N010S06	●	0.15	0.3	0.24	1	0.28	11.3°	50	6	2	1	1.0	1.1	1.2	1.3
MP2XLB R0015N013	●	0.15	0.3	0.24	1.25	0.28	10.7°	50	4	2	1	1.3	1.4	1.5	1.6
MP2XLB R0015N013S06	●	0.15	0.3	0.24	1.25	0.28	11.1°	50	6	2	1	1.3	1.4	1.5	1.6
MP2XLB R0015N015	●	0.15	0.3	0.24	1.5	0.28	10.4°	50	4	2	1	1.6	1.6	1.8	2.0
MP2XLB R0015N015S06	●	0.15	0.3	0.24	1.5	0.28	10.9°	50	6	2	1	1.6	1.6	1.8	2.0
MP2XLB R0015N018	●	0.15	0.3	0.24	1.75	0.28	10.2°	50	4	2	1	1.8	1.9	2.1	2.3
MP2XLB R0015N020	●	0.15	0.3	0.24	2	0.28	9.9°	50	4	2	1	2.1	2.2	2.4	2.6
MP2XLB R0015N025	●	0.15	0.3	0.24	2.5	0.28	9.5°	50	4	2	1	2.6	2.7	3.0	3.3
MP2XLB R0015N030	●	0.15	0.3	0.24	3	0.28	9.1°	50	4	2	1	3.1	3.3	3.6	4.0
MP2XLB R0015N035	●	0.15	0.3	0.24	3.5	0.28	8.7°	50	4	2	1	3.7	3.8	4.2	4.6
MP2XLB R0015N040	●	0.15	0.3	0.24	4	0.28	8.4°	50	4	2	1	4.2	4.4	4.8	5.3
MP2XLB R0020N005	●	0.2	0.4	0.3	0.5	0.37	11.6°	50	4	2	1	0.5	0.5	0.5	0.6
MP2XLB R0020N008	●	0.2	0.4	0.3	0.75	0.37	11.3°	50	4	2	1	0.7	0.8	0.9	0.9

● : Lagerstandard. ★ : Lagerstandard in Japan.

# MP2XLB

Bestellnummer	Lager	RE	DC	APMX	LU	DN	B2	LF	DCON	ZEFP	Typ	Effektive Länge bei Neigungswinkel			
												30°	1°	2°	3°
MP2XLB0020N010	●	0.2	0.4	0.3	1	0.37	11°	50	4	2	1	1.0	1.1	1.2	1.3
MP2XLB0020N010S06	●	0.2	0.4	0.3	1	0.37	11.3°	50	6	2	1	1.0	1.1	1.2	1.3
MP2XLB0020N015	●	0.2	0.4	0.3	1.5	0.37	10.4°	50	4	2	1	1.5	1.6	1.7	1.9
MP2XLB0020N020	●	0.2	0.4	0.3	2	0.37	9.9°	50	4	2	1	2.1	2.2	2.3	2.6
MP2XLB0020N020S06	●	0.2	0.4	0.3	2	0.37	10.6°	50	6	2	1	2.1	2.2	2.3	2.6
MP2XLB0020N025	●	0.2	0.4	0.3	2.5	0.37	9.5°	50	4	2	1	2.6	2.7	2.9	3.3
MP2XLB0020N030	●	0.2	0.4	0.3	3	0.37	9.1°	50	4	2	1	3.1	3.2	3.5	3.9
MP2XLB0020N035	●	0.2	0.4	0.3	3.5	0.37	8.7°	50	4	2	1	3.6	3.8	4.1	4.6
MP2XLB0020N040	●	0.2	0.4	0.3	4	0.37	8.4°	50	4	2	1	4.2	4.3	4.7	5.2
MP2XLB0020N045	●	0.2	0.4	0.3	4.5	0.37	8°	50	4	2	1	4.7	4.9	5.3	5.9
MP2XLB0020N050	●	0.2	0.4	0.3	5	0.37	7.7°	50	4	2	1	5.2	5.4	5.9	6.6
MP2XLB0020N055	●	0.2	0.4	0.3	5.5	0.37	7.5°	50	4	2	1	5.7	6.0	6.5	7.2
MP2XLB0020N060	●	0.2	0.4	0.3	6	0.37	7.2°	50	4	2	1	6.2	6.5	7.1	7.9
MP2XLB0025N010	●	0.25	0.5	0.37	1	0.47	11°	50	4	2	1	1.0	1.0	1.1	1.2
MP2XLB0025N015	●	0.25	0.5	0.37	1.5	0.47	10.4°	50	4	2	1	1.5	1.6	1.7	1.9
MP2XLB0025N015S06	●	0.25	0.5	0.37	1.5	0.47	11°	50	6	2	1	1.5	1.6	1.7	1.9
MP2XLB0025N020	●	0.25	0.5	0.37	2	0.47	9.9°	50	4	2	1	2.1	2.1	2.3	2.6
MP2XLB0025N020S06	●	0.25	0.5	0.37	2	0.47	10.6°	50	6	2	1	2.1	2.1	2.3	2.6
MP2XLB0025N025	●	0.25	0.5	0.37	2.5	0.47	9.5°	50	4	2	1	2.6	2.7	2.9	3.2
MP2XLB0025N025S06	●	0.25	0.5	0.37	2.5	0.47	10.3°	50	6	2	1	2.6	2.7	2.9	3.2
MP2XLB0025N030	●	0.25	0.5	0.37	3	0.47	9.1°	50	4	2	1	3.1	3.2	3.5	3.9
MP2XLB0025N030S06	●	0.25	0.5	0.37	3	0.47	10°	50	6	2	1	3.1	3.2	3.5	3.9
MP2XLB0025N035	●	0.25	0.5	0.37	3.5	0.47	8.7°	50	4	2	1	3.6	3.8	4.1	4.6
MP2XLB0025N040	●	0.25	0.5	0.37	4	0.47	8.3°	50	4	2	1	4.1	4.3	4.7	5.2
MP2XLB0025N045	●	0.25	0.5	0.37	4.5	0.47	8°	50	4	2	1	4.7	4.9	5.3	5.9
MP2XLB0025N050	●	0.25	0.5	0.37	5	0.47	7.7°	50	4	2	1	5.2	5.4	5.9	6.6
MP2XLB0025N055	●	0.25	0.5	0.37	5.5	0.47	7.4°	50	4	2	1	5.7	6.0	6.5	7.2
MP2XLB0025N060	●	0.25	0.5	0.37	6	0.47	7.2°	50	4	2	1	6.2	6.5	7.1	7.9
MP2XLB0025N070	●	0.25	0.5	0.37	7	0.47	6.7°	50	4	2	1	7.3	7.6	8.3	9.2
MP2XLB0025N080	●	0.25	0.5	0.37	8	0.47	6.3°	50	4	2	1	8.3	8.7	9.5	10.5
MP2XLB0025N090	●	0.25	0.5	0.37	9	0.47	5.9°	50	4	2	1	9.4	9.8	10.7	11.9
MP2XLB0025N100	●	0.25	0.5	0.37	10	0.47	5.6°	50	4	2	1	10.4	10.9	11.9	13.2
MP2XLB0030N015	●	0.3	0.6	0.45	1.5	0.57	10.4°	50	4	2	1	1.5	1.6	1.8	2.0
MP2XLB0030N015S06	●	0.3	0.6	0.45	1.5	0.57	11°	50	6	2	1	1.5	1.6	1.8	2.0
MP2XLB0030N020	●	0.3	0.6	0.45	2	0.57	9.9°	50	4	2	1	2.1	2.2	2.4	2.6
MP2XLB0030N020S06	●	0.3	0.6	0.45	2	0.57	10.6°	50	6	2	1	2.1	2.2	2.4	2.6
MP2XLB0030N025	●	0.3	0.6	0.45	2.5	0.57	9.4°	50	4	2	1	2.6	2.7	3.0	3.3
MP2XLB0030N030	●	0.3	0.6	0.45	3	0.57	9°	50	4	2	1	3.1	3.3	3.6	4.0
MP2XLB0030N030S06	●	0.3	0.6	0.45	3	0.57	9.9°	50	6	2	1	3.1	3.3	3.6	4.0
MP2XLB0030N035	●	0.3	0.6	0.45	3.5	0.57	8.6°	50	4	2	1	3.7	3.8	4.2	4.6
MP2XLB0030N040	●	0.3	0.6	0.45	4	0.57	8.2°	50	4	2	1	4.2	4.4	4.8	5.3
MP2XLB0030N040S06	●	0.3	0.6	0.45	4	0.57	9.3°	50	6	2	1	4.2	4.4	4.8	5.3
MP2XLB0030N045	●	0.3	0.6	0.45	4.5	0.57	7.9°	50	4	2	1	4.7	4.9	5.4	5.9
MP2XLB0030N050	●	0.3	0.6	0.45	5	0.57	7.6°	50	4	2	1	5.2	5.5	6.0	6.6
MP2XLB0030N050S06	●	0.3	0.6	0.45	5	0.57	8.8°	50	6	2	1	5.2	5.5	6.0	6.6
MP2XLB0030N055	●	0.3	0.6	0.45	5.5	0.57	7.3°	50	4	2	1	5.8	6.0	6.6	7.3
MP2XLB0030N060	●	0.3	0.6	0.45	6	0.57	7.1°	50	4	2	1	6.3	6.6	7.2	7.9
MP2XLB0030N060S06	●	0.3	0.6	0.45	6	0.57	8.3°	50	6	2	1	6.3	6.6	7.2	7.9

# MP2XLB

Bestellnummer	Lager	RE	DC	APMX	LU	DN	B2	LF	DCON	ZEFP	Typ	Effektive Länge bei Neigungswinkel			
												30°	1°	2°	3°
MP2XLB0030N065	●	0.3	0.6	0.45	6.5	0.57	6.8°	50	4	2	1	6.8	7.1	7.8	8.6
MP2XLB0030N070	●	0.3	0.6	0.45	7	0.57	6.6°	50	4	2	1	7.3	7.6	8.4	9.3
MP2XLB0030N080	●	0.3	0.6	0.45	8	0.57	6.2°	50	4	2	1	8.4	8.7	9.6	10.6
MP2XLB0030N080S06	●	0.3	0.6	0.45	8	0.57	7.6°	50	6	2	1	8.4	8.7	9.6	10.6
MP2XLB0030N085	●	0.3	0.6	0.45	8.5	0.57	6°	50	4	2	1	8.9	9.3	10.2	11.3
MP2XLB0030N090	●	0.3	0.6	0.45	9	0.57	5.8°	50	4	2	1	9.4	9.8	10.8	11.9
MP2XLB0030N095	●	0.3	0.6	0.45	9.5	0.57	5.7°	50	4	2	1	9.9	10.4	11.4	12.6
MP2XLB0030N100	●	0.3	0.6	0.45	10	0.57	5.5°	50	4	2	1	10.5	10.9	12.0	13.2
MP2XLB0030N110	●	0.3	0.6	0.45	11	0.57	5.2°	50	4	2	1	11.5	12.0	13.2	14.6
MP2XLB0030N120	●	0.3	0.6	0.45	12	0.57	5°	50	4	2	1	12.5	13.1	14.4	15.9
MP2XLB0040N020	●	0.4	0.8	0.6	2	0.77	9.9°	50	4	2	1	2.1	2.2	2.4	2.6
MP2XLB0040N020S06	●	0.4	0.8	0.6	2	0.77	10.6°	50	6	2	1	2.1	2.2	2.4	2.6
MP2XLB0040N024S06	●	0.4	0.8	0.6	2.4	0.77	10.3°	50	6	2	1	2.5	2.6	2.8	3.1
MP2XLB0040N030	●	0.4	0.8	0.6	3	0.77	8.9°	50	4	2	1	3.1	3.3	3.6	3.9
MP2XLB0040N030S06	●	0.4	0.8	0.6	3	0.77	9.9°	50	6	2	1	3.1	3.3	3.6	3.9
MP2XLB0040N040	●	0.4	0.8	0.6	4	0.77	8.2°	50	4	2	1	4.2	4.4	4.8	5.2
MP2XLB0040N040S06	●	0.4	0.8	0.6	4	0.77	9.3°	50	6	2	1	4.2	4.4	4.8	5.2
MP2XLB0040N050	●	0.4	0.8	0.6	5	0.77	7.5°	50	4	2	1	5.2	5.5	6.0	6.6
MP2XLB0040N060	●	0.4	0.8	0.6	6	0.77	6.9°	50	4	2	1	6.3	6.5	7.2	7.9
MP2XLB0040N070	●	0.4	0.8	0.6	7	0.77	6.5°	50	4	2	1	7.3	7.6	8.4	9.2
MP2XLB0040N080	●	0.4	0.8	0.6	8	0.77	6°	50	4	2	1	8.4	8.7	9.5	10.6
MP2XLB0040N090	●	0.4	0.8	0.6	9	0.77	5.7°	50	4	2	1	9.4	9.8	10.7	11.9
MP2XLB0040N100	●	0.4	0.8	0.6	10	0.77	5.4°	50	4	2	1	10.5	10.9	11.9	13.2
MP2XLB0040N120	●	0.4	0.8	0.6	12	0.77	4.8°	50	4	2	1	12.5	13.1	14.3	15.9
MP2XLB0050N030	●	0.5	1	0.75	3	0.96	8.7°	50	4	2	1	3.2	3.4	3.7	4.1
MP2XLB0050N030S06	●	0.5	1	0.75	3	0.96	9.8°	50	6	2	1	3.2	3.4	3.7	4.1
MP2XLB0050N040	●	0.5	1	0.75	4	0.96	7.9°	50	4	2	1	4.3	4.5	4.9	5.4
MP2XLB0050N040S06	●	0.5	1	0.75	4	0.96	9.2°	50	6	2	1	4.3	4.5	4.9	5.4
MP2XLB0050N050	●	0.5	1	0.75	5	0.96	7.3°	50	4	2	1	5.3	5.6	6.1	6.7
MP2XLB0050N050S06	●	0.5	1	0.75	5	0.96	8.6°	50	6	2	1	5.3	5.6	6.1	6.7
MP2XLB0050N060	●	0.5	1	0.75	6	0.96	6.7°	50	4	2	1	6.4	6.7	7.3	8.1
MP2XLB0050N060S06	●	0.5	1	0.75	6	0.96	8.2°	50	6	2	1	6.4	6.7	7.3	8.1
MP2XLB0050N070	●	0.5	1	0.75	7	0.96	6.2°	50	4	2	1	7.4	7.8	8.5	9.4
MP2XLB0050N080	●	0.5	1	0.75	8	0.96	5.8°	50	4	2	1	8.5	8.9	9.7	10.7
MP2XLB0050N080S06	●	0.5	1	0.75	8	0.96	7.3°	50	6	2	1	8.5	8.9	9.7	10.7
MP2XLB0050N090	●	0.5	1	0.75	9	0.96	5.5°	50	4	2	1	9.5	10.0	10.9	12.0
MP2XLB0050N100	●	0.5	1	0.75	10	0.96	5.1°	50	4	2	1	10.6	11.1	12.1	13.4
MP2XLB0050N100S06	●	0.5	1	0.75	10	0.96	6.7°	60	6	2	1	10.6	11.1	12.1	13.4
MP2XLB0050N120	●	0.5	1	0.75	12	0.96	4.6°	50	4	2	1	12.7	13.2	14.5	16.0
MP2XLB0050N120S06	●	0.5	1	0.75	12	0.96	6.1°	60	6	2	1	12.7	13.2	14.5	16.0
MP2XLB0050N140	●	0.5	1	0.75	14	0.96	4.2°	55	4	2	1	14.8	15.4	16.9	18.7
MP2XLB0050N160	●	0.5	1	0.75	16	0.96	3.8°	55	4	2	1	16.9	17.6	19.3	21.3
MP2XLB0050N160S06	●	0.5	1	0.75	16	0.96	5.2°	65	6	2	1	16.9	17.6	19.3	21.3

# MP2XLB

Bestellnummer	Lager	RE	DC	APMX	LU	DN	B2	LF	DCON	ZEFP	Typ	Effektive Länge bei Neigungswinkel			
												30°	1°	2°	3°
MP2XLB0050N180	●	0.5	1	0.75	18	0.96	3.5°	55	4	2	1	18.9	19.8	21.7	24.0
MP2XLB0050N200	●	0.5	1	0.75	20	0.96	3.3°	55	4	2	1	21.0	22.0	24.1	26.6
MP2XLB0050N200S06	●	0.5	1	0.75	20	0.96	4.6°	65	6	2	1	21.0	22.0	24.1	26.6
MP2XLB0060N060	●	0.6	1.2	0.9	6	1.16	6.6°	50	4	2	1	6.4	6.7	7.3	8.0
MP2XLB0060N060S06	●	0.6	1.2	0.9	6	1.16	8.1°	55	6	2	1	6.4	6.7	7.3	8.0
MP2XLB0060N080	●	0.6	1.2	0.9	8	1.16	5.7°	50	4	2	1	8.5	8.9	9.7	10.7
MP2XLB0060N080S06	●	0.6	1.2	0.9	8	1.16	7.3°	55	6	2	1	8.5	8.9	9.7	10.7
MP2XLB0060N100	●	0.6	1.2	0.9	10	1.16	5°	50	4	2	1	10.6	11.0	12.1	13.3
MP2XLB0060N100S06	●	0.6	1.2	0.9	10	1.16	6.6°	55	6	2	1	10.6	11.0	12.1	13.3
MP2XLB0060N120	●	0.6	1.2	0.9	12	1.16	4.4°	50	4	2	1	12.7	13.2	14.5	16.0
MP2XLB0060N120S06	●	0.6	1.2	0.9	12	1.16	6°	65	6	2	1	12.7	13.2	14.5	16.0
MP2XLB0060N140	●	0.6	1.2	0.9	14	1.16	4°	55	4	2	1	14.8	15.4	16.9	18.7
MP2XLB0060N160	●	0.6	1.2	0.9	16	1.16	3.7°	55	4	2	1	16.9	17.6	19.3	21.3
MP2XLB0060N160S06	●	0.6	1.2	0.9	16	1.16	5.1°	65	6	2	1	16.9	17.6	19.3	21.3
MP2XLB0060N180	●	0.6	1.2	0.9	18	1.16	3.4°	60	4	2	1	18.9	19.8	21.7	24.0
MP2XLB0060N200	●	0.6	1.2	0.9	20	1.16	3.1°	60	4	2	1	21.0	21.9	24.0	26.6
MP2XLB0060N240	●	0.6	1.2	0.9	24	1.16	2.7°	60	4	2	1	25.2	26.3	28.8	*
MP2XLB0070N080	●	0.7	1.4	1.05	8	1.34	5.5°	50	4	2	1	8.4	8.8	9.6	10.6
MP2XLB0070N120	●	0.7	1.4	1.05	12	1.34	4.3°	50	4	2	1	12.6	13.1	14.4	15.9
MP2XLB0070N160	●	0.7	1.4	1.05	16	1.34	3.5°	50	4	2	1	16.8	17.5	19.2	21.2
MP2XLB0075N030	●	0.75	1.5	1.1	3	1.44	8.6°	50	4	2	1	3.1	3.3	3.6	3.9
MP2XLB0075N040	●	0.75	1.5	1.1	4	1.44	7.7°	50	4	2	1	4.2	4.4	4.8	5.2
MP2XLB0075N060	●	0.75	1.5	1.1	6	1.44	6.3°	50	4	2	1	6.3	6.6	7.2	7.9
MP2XLB0075N060S06	●	0.75	1.5	1.1	6	1.44	8°	50	6	2	1	6.3	6.6	7.2	7.9
MP2XLB0075N080	●	0.75	1.5	1.1	8	1.44	5.4°	50	4	2	1	8.4	8.8	9.6	10.6
MP2XLB0075N080S06	●	0.75	1.5	1.1	8	1.44	7.2°	60	6	2	1	8.4	8.8	9.6	10.6
MP2XLB0075N100	●	0.75	1.5	1.1	10	1.44	4.7°	50	4	2	1	10.5	11.0	12.0	13.2
MP2XLB0075N100S06	●	0.75	1.5	1.1	10	1.44	6.5°	60	6	2	1	10.5	11.0	12.0	13.2
MP2XLB0075N120	●	0.75	1.5	1.1	12	1.44	4.2°	50	4	2	1	12.6	13.1	14.4	15.9
MP2XLB0075N120S06	●	0.75	1.5	1.1	12	1.44	5.9°	60	6	2	1	12.6	13.1	14.4	15.9
MP2XLB0075N140	●	0.75	1.5	1.1	14	1.44	3.8°	55	4	2	1	14.7	15.3	16.8	18.5
MP2XLB0075N160	●	0.75	1.5	1.1	16	1.44	3.4°	55	4	2	1	16.8	17.5	19.2	21.2
MP2XLB0075N160S06	●	0.75	1.5	1.1	16	1.44	5°	60	6	2	1	16.8	17.5	19.2	21.2
MP2XLB0075N180	●	0.75	1.5	1.1	18	1.44	3.1°	60	4	2	1	18.9	19.7	21.6	23.8
MP2XLB0075N200	●	0.75	1.5	1.1	20	1.44	2.9°	60	4	2	1	21.0	21.9	23.9	*
MP2XLB0075N220	●	0.75	1.5	1.1	22	1.44	2.7°	60	4	2	1	23.0	24.0	26.3	*
MP2XLB0080N080	●	0.8	1.6	1.2	8	1.54	5.3°	55	4	2	1	8.4	8.8	9.6	10.5
MP2XLB0080N120	●	0.8	1.6	1.2	12	1.54	4.1°	55	4	2	1	12.6	13.1	14.4	15.9
MP2XLB0080N160	●	0.8	1.6	1.2	16	1.54	3.3°	55	4	2	1	16.8	17.5	19.1	21.2
MP2XLB0080N200	●	0.8	1.6	1.2	20	1.54	2.8°	55	4	2	1	21.0	21.9	23.9	*
MP2XLB0090N080	●	0.9	1.8	1.4	8	1.74	5.1°	55	4	2	1	8.4	8.8	9.6	10.5
MP2XLB0090N120	●	0.9	1.8	1.4	12	1.74	3.9°	55	4	2	1	12.6	13.1	14.3	15.8
MP2XLB0090N160	●	0.9	1.8	1.4	16	1.74	3.1°	55	4	2	1	16.8	17.5	19.1	21.1
MP2XLB0090N200	●	0.9	1.8	1.4	20	1.74	2.6°	55	4	2	1	20.9	21.8	23.9	*
MP2XLB0100N040	●	1	2	1.5	4	1.94	7.2°	50	4	2	1	4.2	4.4	4.7	5.2
MP2XLB0100N040S06	●	1	2	1.5	4	1.94	9°	50	6	2	1	4.2	4.4	4.7	5.2
MP2XLB0100N060	●	1	2	1.5	6	1.94	5.8°	50	4	2	1	6.3	6.6	7.1	7.8
MP2XLB0100N060S06	●	1	2	1.5	6	1.94	7.8°	50	6	2	1	6.3	6.6	7.1	7.8

\* Keine Interferenz

# MP2XLB

Bestellnummer	Lager	RE	DC	APMX	LU	DN	B2	LF	DCON	ZEFP	Typ	Effektive Länge bei Neigungswinkel			
												30°	1°	2°	3°
MP2XLB0100N080	●	1	2	1.5	8	1.94	4.8°	50	4	2	1	8.4	8.8	9.5	10.5
MP2XLB0100N080S06	●	1	2	1.5	8	1.94	6.9°	50	6	2	1	8.4	8.8	9.5	10.5
MP2XLB0100N100	●	1	2	1.5	10	1.94	4.2°	50	4	2	1	10.5	10.9	11.9	13.1
MP2XLB0100N100S06	●	1	2	1.5	10	1.94	6.2°	50	6	2	1	10.5	10.9	11.9	13.1
MP2XLB0100N120	●	1	2	1.5	12	1.94	3.6°	50	4	2	1	12.6	13.1	14.3	15.8
MP2XLB0100N120S06	●	1	2	1.5	12	1.94	5.6°	60	6	2	1	12.6	13.1	14.3	15.8
MP2XLB0100N140	●	1	2	1.5	14	1.94	3.2°	55	4	2	1	14.7	15.3	16.7	18.4
MP2XLB0100N140S06	●	1	2	1.5	14	1.94	5.1°	60	6	2	1	14.7	15.3	16.7	18.4
MP2XLB0100N160	●	1	2	1.5	16	1.94	2.9°	55	4	2	1	16.8	17.5	19.1	*
MP2XLB0100N160S06	●	1	2	1.5	16	1.94	4.7°	65	6	2	1	16.8	17.5	19.1	21.1
MP2XLB0100N180	●	1	2	1.5	18	1.94	2.7°	55	4	2	1	18.9	19.7	21.5	*
MP2XLB0100N180S06	●	1	2	1.5	18	1.94	4.3°	65	6	2	1	18.9	19.7	21.5	23.8
MP2XLB0100N200	●	1	2	1.5	20	1.94	2.4°	65	4	2	1	20.9	21.8	23.9	*
MP2XLB0100N200S06	●	1	2	1.5	20	1.94	4°	65	6	2	1	20.9	21.8	23.9	26.4
MP2XLB0100N220	●	1	2	1.5	22	1.94	2.3°	65	4	2	1	23.0	24.0	26.3	*
MP2XLB0100N250	●	1	2	1.5	25	1.94	2°	65	4	2	1	26.2	27.3	*	*
MP2XLB0100N250S06	●	1	2	1.5	25	1.94	3.5°	90	6	2	1	26.2	27.3	29.9	33
MP2XLB0100N300	●	1	2	1.5	30	1.94	1.7°	80	4	2	1	31.4	32.7	*	*
MP2XLB0100N300S06	●	1	2	1.5	30	1.94	3°	90	6	2	1	31.4	32.7	35.9	*
MP2XLB0100N350	●	1	2	1.5	35	1.94	1.5°	80	4	2	1	36.6	38.2	*	*
MP2XLB0100N350S06	●	1	2	1.5	35	1.94	2.7°	90	6	2	1	36.6	38.2	41.8	*
MP2XLB0100N400	●	1	2	1.5	40	1.94	1.4°	80	4	2	1	41.8	43.6	*	*
MP2XLB0100N400S06	●	1	2	1.5	40	1.94	2.4°	90	6	2	1	41.8	43.6	47.8	*
MP2XLB0125N100	●	1.25	2.5	1.9	10	2.4	3.5°	55	4	2	1	10.4	10.8	11.8	12.9
MP2XLB0125N150	●	1.25	2.5	1.9	15	2.4	2.5°	55	4	2	1	15.6	16.3	17.8	*
MP2XLB0125N200	●	1.25	2.5	1.9	20	2.4	2°	55	4	2	1	20.8	21.7	*	*
MP2XLB0125N250	●	1.25	2.5	1.9	25	2.4	1.6°	70	4	2	1	26.1	27.2	*	*
MP2XLB0125N300	●	1.25	2.5	1.9	30	2.4	1.4°	70	4	2	1	31.3	32.6	*	*
MP2XLB0125N350	●	1.25	2.5	1.9	35	2.4	1.2°	70	4	2	1	36.5	38.1	*	*
MP2XLB0150N060S03	●	1.5	3	2.3	6	2.9	–	60	3	2	1	*	*	*	*
MP2XLB0150N080	●	1.5	3	2.3	8	2.9	6.3°	60	6	2	1	8.3	8.6	9.3	10.2
MP2XLB0150N100	●	1.5	3	2.3	10	2.9	5.5°	60	6	2	1	10.4	10.8	11.7	12.9
MP2XLB0150N120	●	1.5	3	2.3	12	2.9	4.9°	60	6	2	1	12.5	13.0	14.1	15.5
MP2XLB0150N140	●	1.5	3	2.3	14	2.9	4.4°	60	6	2	1	14.6	15.2	16.5	18.2
MP2XLB0150N160	●	1.5	3	2.3	16	2.9	4°	70	6	2	1	16.7	17.3	18.9	20.8
MP2XLB0150N200	●	1.5	3	2.3	20	2.9	3.4°	70	6	2	1	20.8	21.7	23.7	26.1
MP2XLB0150N250	●	1.5	3	2.3	25	2.9	2.8°	70	6	2	1	26.1	27.2	29.7	*
MP2XLB0150N300	●	1.5	3	2.3	30	2.9	2.5°	70	6	2	1	31.3	32.6	35.7	*
MP2XLB0150N350	●	1.5	3	2.3	35	2.9	2.2°	90	6	2	1	36.5	38.0	41.7	*
MP2XLB0150N400	●	1.5	3	2.3	40	2.9	1.9°	90	6	2	1	41.7	43.5	*	*
MP2XLB0175N150	●	1.75	3.5	2.6	15	3.4	3.8°	65	6	2	1	15.6	16.2	17.7	19.4
MP2XLB0175N250	●	1.75	3.5	2.6	25	3.4	2.5°	65	6	2	1	26.0	27.1	29.6	*

\* Keine Interferenz

# MP2XLB

Bestellnummer	Lager	RE	DC	APMX	LU	DN	B2	LF	DCON	ZEFP	Typ	Effektive Länge bei Neigungswinkel			
												30°	1°	2°	3°
MP2XLB0175N350	●	1.75	3.5	2.6	35	3.4	1.9°	90	6	2	1	36.5	38.0	*	*
MP2XLB0175N450	●	1.75	3.5	2.6	45	3.4	1.5°	90	6	2	1	46.9	48.9	*	*
MP2XLB0200N080S04	●	2	4	3	8	3.9	–	65	4	2	1	*	*	*	*
MP2XLB0200N100	●	2	4	3	10	3.9	4.5°	65	6	2	1	10.4	10.8	11.6	12.7
MP2XLB0200N120	●	2	4	3	12	3.9	3.9°	65	6	2	1	12.5	12.9	14.0	15.4
MP2XLB0200N140	●	2	4	3	14	3.9	3.4°	65	6	2	1	14.6	15.1	16.4	18.0
MP2XLB0200N160	●	2	4	3	16	3.9	3.1°	70	6	2	1	16.6	17.3	18.8	20.7
MP2XLB0200N200	●	2	4	3	20	3.9	2.6°	70	6	2	1	20.8	21.7	23.6	*
MP2XLB0200N250	●	2	4	3	25	3.9	2.1°	70	6	2	1	26.0	27.1	29.6	*
MP2XLB0200N300	●	2	4	3	30	3.9	1.8°	80	6	2	1	31.2	32.6	*	*
MP2XLB0200N350	●	2	4	3	35	3.9	1.6°	80	6	2	1	36.5	38.0	*	*
MP2XLB0200N400	●	2	4	3	40	3.9	1.4°	90	6	2	1	41.7	43.5	*	*
MP2XLB0200N450	●	2	4	3	45	3.9	1.2°	90	6	2	1	46.9	48.9	*	*
MP2XLB0200N500	●	2	4	3	50	3.9	1.1°	100	6	2	1	52.1	54.3	*	*
MP2XLB0250N150	●	2.5	5	3.8	15	4.9	2°	70	6	2	1	15.6	16.2	*	*
MP2XLB0250N200	●	2.5	5	3.8	20	4.9	1.5°	70	6	2	1	20.8	21.6	*	*
MP2XLB0250N250	●	2.5	5	3.8	25	4.9	1.2°	70	6	2	1	26.0	27.1	*	*
MP2XLB0250N300	●	2.5	5	3.8	30	4.9	1°	80	6	2	1	31.2	*	*	*
MP2XLB0250N350	●	2.5	5	3.8	35	4.9	0.9°	80	6	2	1	36.4	*	*	*
MP2XLB0250N400	●	2.5	5	3.8	40	4.9	0.8°	90	6	2	1	41.7	*	*	*
MP2XLB0300N200	●	3	6	6	20	5.85	–	70	6	2	2	*	*	*	*
MP2XLB0300N250	●	3	6	6	25	5.85	–	70	6	2	2	*	*	*	*
MP2XLB0300N300	●	3	6	6	30	5.85	–	80	6	2	2	*	*	*	*
MP2XLB0300N400	●	3	6	6	40	5.85	–	90	6	2	2	*	*	*	*
MP2XLB0300N500	●	3	6	6	50	5.85	–	100	6	2	2	*	*	*	*

\* Keine Interferenz





# MP2XLB

## SCHNITTDATENEMPFEHLUNGEN

### 3D FRÄSEN

Material	RE	LU	n	Vf	ap
P C-Stahl, legierter Stahl, legierter Werkzeugstahl, vergüteter Stahl, Ausscheidungsgehärteter, rostfreier Stahl	0.05	0.3	50000	200	0.002
		0.5	50000	200	0.001
	0.1	0.5	50000	400	0.003
		1	50000	400	0.002
		1.5	40000	300	0.001
		2	40000	200	0.001
		2.5	40000	100	0.001
	0.15	1	50000	600	0.007
		1.5	50000	600	0.005
		2	50000	600	0.003
		2.5	40000	400	0.003
		3	40000	300	0.002
		3.5	30000	250	0.002
	0.2	4	30000	200	0.002
		1	50000	1800	0.015
		2	50000	1300	0.01
		3	50000	900	0.005
		4	40000	600	0.004
		5	40000	400	0.003
	0.25	6	30000	200	0.002
		2	50000	2500	0.02
		3	50000	1500	0.015
		4	45000	1200	0.01
		5	45000	900	0.007
		6	36000	600	0.006
		7	32000	400	0.005
	0.3	8	32000	300	0.003
		10	26000	200	0.002
		2	50000	3500	0.03
		3	50000	3500	0.03
		4	44000	2500	0.02
		5	37000	1200	0.01
		6	37000	1000	0.008
		7	35000	750	0.008
		8	35000	600	0.006
		9	30000	500	0.004
		10	30000	500	0.003
		11	22000	300	0.002
	0.4	12	22000	200	0.002
		2	50000	4400	0.04
		3	50000	4000	0.04
		4	50000	4000	0.02
		5	35000	2400	0.02
		6	35000	2400	0.02
		7	30000	1500	0.015
		8	30000	1500	0.01
		10	30000	700	0.008
		12	22000	500	0.006

# MP2XLB

Material	RE	LU	n	Vf	ap
N Kupfer, Kupferlegierungen	0.05	0.3	50000	200	0.004
		0.5	50000	200	0.002
	0.1	0.5	50000	320	0.006
		1	50000	320	0.004
		1.5	40000	240	0.002
		2	40000	160	0.002
		2.5	40000	80	0.002
	0.15	1	50000	480	0.014
		1.5	50000	480	0.01
		2	50000	480	0.006
		2.5	40000	320	0.006
		3	40000	240	0.004
	0.2	3.5	30000	200	0.004
		4	30000	160	0.004
		1	50000	1400	0.03
		2	50000	1000	0.02
		3	50000	700	0.01
		4	40000	480	0.008
	0.25	5	40000	320	0.006
		6	30000	160	0.004
		2	50000	2000	0.04
		3	50000	1200	0.03
		4	45000	950	0.02
		5	45000	700	0.014
		6	36000	480	0.012
		7	32000	320	0.01
		8	32000	240	0.006
		10	26000	160	0.004
	0.3	2	50000	2800	0.06
		3	50000	2800	0.06
		4	44000	2000	0.04
		5	37000	950	0.02
		6	37000	800	0.016
		7	35000	600	0.016
		8	35000	480	0.012
		9	30000	400	0.008
		10	30000	400	0.006
		11	22000	240	0.004
		12	22000	160	0.004
		0.4	2	50000	3500
	3		50000	3200	0.08
	4		50000	3200	0.04
	5		35000	1900	0.04
	6		35000	1900	0.04
	7		30000	1200	0.03
	8		30000	1200	0.02
	10		30000	560	0.016
	12		22000	400	0.012

# MP2XLB

Material	RE	LU	n	Vf	ap
H Gehärteter Stahl (45-55 HRC)	0.05	0.3	50000	200	0.002
		0.5	50000	200	0.002
	0.1	0.5	50000	320	0.003
		1	50000	320	0.002
		1.5	40000	240	0.001
		2	40000	160	0.001
		2.5	40000	80	0.001
	0.15	1	50000	480	0.007
		1.5	50000	480	0.005
		2	50000	480	0.003
		2.5	40000	320	0.003
		3	40000	240	0.002
	0.2	3.5	30000	200	0.002
		4	30000	160	0.002
		1	50000	1400	0.015
		2	50000	1000	0.01
		3	50000	700	0.005
		4	40000	480	0.004
	0.25	5	40000	320	0.003
		6	30000	160	0.002
		2	50000	2000	0.02
		3	50000	1200	0.015
		4	45000	950	0.01
		5	45000	700	0.007
		6	36000	480	0.006
		7	32000	320	0.005
		8	32000	240	0.003
		10	26000	160	0.002
	0.3	2	50000	2800	0.03
		3	50000	2800	0.03
		4	44000	2000	0.02
		5	37000	950	0.01
		6	37000	800	0.008
		7	35000	600	0.008
		8	35000	480	0.006
		9	30000	400	0.004
		10	30000	400	0.003
		11	22000	240	0.002
		12	22000	160	0.002
		0.4	2	50000	3500
	3		50000	3200	0.04
	4		50000	3200	0.02
	5		35000	1900	0.02
	6		35000	1900	0.02
	7		30000	1200	0.015
	8		30000	1200	0.01
	10		30000	560	0.008
	12		22000	400	0.006

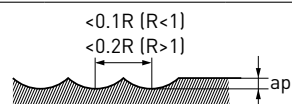

# MP2XLB

## 3D FRÄSEN

Material	RE	LU	n	Vf	ap
P C-Stahl, legierter Stahl, legierter Werkzeugstahl, vergüteter Stahl, Ausscheidungsgehärteter, rostfreier Stahl	0.5	3	40000	4000	0.05
		4	40000	4000	0.05
		6	35000	3000	0.03
		8	30000	2000	0.02
		10	20000	1000	0.01
		12	20000	1000	0.01
		14	18000	600	0.008
		16	18000	500	0.008
		18	13000	300	0.005
		20	13000	250	0.005
	0.6	6	40000	4400	0.04
		8	40000	4000	0.04
		10	27000	1900	0.02
		12	16000	1400	0.02
		18	15000	700	0.008
		24	11000	300	0.006
	0.7	8	40000	4000	0.05
		12	26000	2000	0.04
		16	17000	1400	0.03
	0.75	6	40000	6000	0.07
		8	40000	6000	0.07
		10	40000	5000	0.06
		12	32000	3400	0.04
		16	15000	1400	0.03
		20	12000	900	0.02
		30	9000	400	0.01
	0.8	8	40000	6000	0.08
		12	36000	4500	0.06
		16	14000	1400	0.04
		20	12000	1000	0.03
	0.9	8	40000	6600	0.09
		12	40000	5000	0.07
		16	28000	2800	0.04
		20	10000	800	0.03
	1	4	40000	8000	0.1
		6	40000	8000	0.1
		8	40000	6000	0.1
		10	40000	5000	0.08
		12	40000	5000	0.08
		16	32000	3500	0.05
20		10000	1000	0.04	
25		10000	1000	0.04	
30		10000	800	0.02	
35		10000	600	0.02	
40	8000	400	0.01		

# MP2XLB

Material	RE	LU	n	Vf	ap
N Kupfer, Kupferlegierungen	0.5	3	40000	3200	0.1
		4	40000	3200	0.1
		6	35000	2400	0.06
		8	30000	1600	0.04
		10	20000	800	0.02
		12	20000	800	0.02
		14	18000	480	0.016
		16	18000	400	0.016
		18	13000	240	0.01
		20	13000	200	0.01
	0.6	6	40000	3500	0.08
		8	40000	3200	0.08
		10	27000	1500	0.04
		12	16000	1100	0.04
		18	15000	560	0.016
		24	11000	240	0.012
	0.7	8	40000	2560	0.1
		12	26000	1280	0.08
		16	17000	896	0.06
	0.75	6	36000	4300	0.14
		8	36000	4300	0.14
		10	36000	3600	0.12
		12	29000	2400	0.08
		16	15000	1100	0.06
		20	12000	720	0.04
	0.8	30	9000	320	0.02
		8	32000	3800	0.16
		12	29000	2800	0.12
		16	14000	1100	0.08
	0.9	20	12000	800	0.06
		8	32000	4200	0.18
		12	32000	3200	0.14
		16	22000	1800	0.08
	1	20	10000	640	0.06
		4	32000	5000	0.2
		6	32000	5000	0.2
		8	32000	3800	0.2
		10	32000	3200	0.16
		12	32000	3200	0.16
		16	26000	2200	0.1
20		10000	800	0.08	
25		10000	800	0.08	
30		10000	640	0.04	
35	10000	480	0.04		
40	8000	320	0.02		

# MP2XLB

Material	RE	LU	n	Vf	ap
H Gehärteter Stahl (45-55 HRC)	0.5	3	40000	3200	0.05
		4	40000	3200	0.05
		6	35000	2400	0.03
		8	30000	1600	0.02
		10	20000	800	0.01
		12	20000	800	0.01
		14	18000	480	0.008
		16	18000	400	0.008
		18	13000	240	0.005
		20	13000	200	0.005
	0.6	6	40000	3500	0.04
		8	40000	3200	0.04
		10	27000	1500	0.02
		12	16000	1100	0.02
		18	15000	560	0.008
		24	11000	240	0.006
	0.7	8	40000	3200	0.05
		12	26000	1600	0.04
		16	17000	1120	0.03
	0.75	6	36000	4300	0.07
		8	36000	4300	0.07
		10	36000	3600	0.06
		12	29000	2400	0.04
		16	15000	1100	0.03
		20	12000	720	0.02
	0.8	30	9000	320	0.01
		8	32000	3800	0.08
		12	29000	2800	0.06
		16	14000	1100	0.04
	0.9	20	12000	800	0.03
		8	32000	4200	0.09
		12	32000	3200	0.07
	1	16	22000	1800	0.04
		20	10000	640	0.03
		4	32000	5000	0.1
6		32000	5000	0.1	
8		32000	3800	0.1	
10		32000	3200	0.08	
12		32000	3200	0.08	
16		26000	2200	0.05	
20		10000	800	0.04	
25		10000	800	0.04	
30	10000	640	0.02		
35	10000	480	0.02		
40	8000	320	0.01		

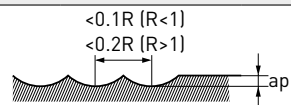

# MP2XLB

## 3D FRÄSEN

Material	RE	LU	n	Vf	ap
P C-Stahl, legierter Stahl, legierter Werkzeugstahl, vergüteter Stahl, Ausscheidungsgehärteter, rostfreier Stahl	1.25	10	36000	6000	0.12
		15	32000	4500	0.1
		20	26000	3200	0.07
		25	12000	1400	0.06
		30	8000	900	0.04
		35	8000	800	0.02
	1.5	6	32000	7000	0.15
		10	32000	7000	0.15
		16	32000	5000	0.1
		20	27000	3800	0.1
		25	21000	2700	0.08
		30	10000	700	0.08
		35	6000	700	0.06
	1.75	40	6000	600	0.04
		15	27500	4400	0.13
		25	23000	3600	0.1
		35	10000	1400	0.08
	2	45	7500	900	0.04
		10	24000	6000	0.2
		20	24000	3800	0.15
		30	20000	3000	0.1
		40	12000	1700	0.1
	2.5	50	8000	1000	0.05
		20	22000	6000	0.2
		25	22000	4400	0.2
		30	22000	3800	0.15
	3	40	22000	3600	0.1
20		20000	6000	0.2	
30		20000	6000	0.2	
40		20000	4500	0.15	
		50	20000	3000	0.15

# MP2XLB

Material	RE	LU	n	Vf	ap
N Kupfer, Kupferlegierungen	1.25	10	29000	3800	0.24
		15	26000	2900	0.2
		20	21000	2000	0.14
		25	8000	720	0.12
		30	8000	700	0.08
		35	8000	510	0.04
	1.5	6	22000	3800	0.3
		10	22000	3800	0.3
		16	22000	2700	0.2
		20	22000	2400	0.2
		25	17000	1700	0.16
		30	6000	560	0.16
		35	6000	560	0.12
	1.75	40	6000	480	0.08
		15	18000	2300	0.26
		25	18000	2200	0.2
		35	10000	1100	0.16
	2	45	7500	720	0.08
		10	16000	3200	0.4
		20	16000	2000	0.3
		30	16000	1900	0.2
		40	12000	1400	0.2
	2.5	50	8000	800	0.1
		20	13000	2800	0.4
		25	13000	2000	0.4
30		13000	1700	0.3	
3	40	13000	1600	0.2	
	20	11000	2600	0.4	
	30	11000	2600	0.4	
	40	11000	2000	0.3	
	50	11000	1300	0.3	



# MP2XLB

Material	RE	LU	n	Vf	ap
H Gehärteter Stahl (45-55HRC)	1.25	10	29000	3800	0.12
		15	26000	2900	0.1
		20	21000	2000	0.07
		25	8000	720	0.06
		30	8000	700	0.04
		35	8000	640	0.02
	1.5	6	26000	4500	0.15
		10	26000	4500	0.15
		16	26000	3200	0.1
		20	22000	2400	0.1
		25	17000	1700	0.08
		30	6000	560	0.08
		35	6000	560	0.06
	1.75	40	6000	480	0.04
		15	22000	2800	0.13
		25	18000	2200	0.1
		35	10000	1100	0.08
	2	45	7500	720	0.04
		10	19000	3800	0.2
		20	19000	2400	0.15
		30	16000	1900	0.1
		40	12000	1400	0.1
	2.5	50	8000	800	0.05
		20	18000	3800	0.2
		25	18000	2800	0.2
		30	18000	2400	0.15
	3	40	18000	2300	0.1
20		16000	3800	0.2	
30		16000	3800	0.2	
40		16000	2800	0.15	
50		16000	1900	0.15	

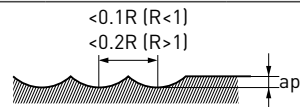

1. Wenn der Neigungswinkel der Bearbeitungsfläche groß ist oder unter hohen Schnittlasten gearbeitet wird, wie in Ecken, müssen Drehzahl und Vorschub reduziert werden.
2. Die Verwendung von Ölnebel wird beim Fräsen mit kleinem Durchmesser empfohlen.
3. Bei geringen Schnitttiefen (ap) können Drehzahl und Vorschub erhöht werden.
4. Die Schnittbedingungen können sich aufgrund der Auskragung, der Schnitttiefe und des Werkzeugmaschinenzustands erheblich unterscheiden. Bitte nutzen Sie die obige Tabelle zu Referenzzwecken.
5. Benutzen Sie VF2XLB für gehärteten Stahl über 55 HRC.
6. Nutzen Sie für die Schnittbedingungen für austenitischen rostfreien Stahl und Titanlegierungen die Tabelle für Stahl mit hoher Härte (45-55 HRC), aber reduzieren Sie die Spindeldrehzahl um 40 % und die Vorschubgeschwindigkeit um 55 %.

# MP3XB



## KUGELKOPFFRÄSER, 3-SCHNEIDIG, KONISCHER HINTERSCHLIFF

P N H



RE < 3	4 < RE
--------	--------



DCON=6	DCON=8
--------	--------



DCON=10	12 < DCON
---------	-----------

±0.005	±0.010
--------	--------

0	0
---	---

0	0
---	---

-0.009	-0.011
--------	--------

Effektive Auskragung  
bei Neigungswinkel

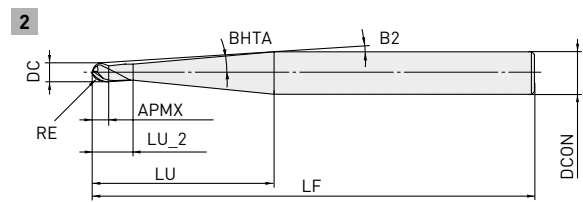
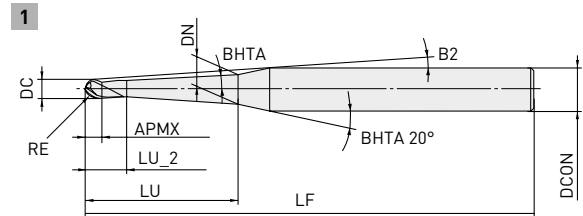
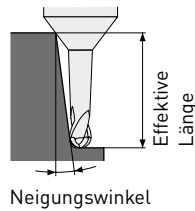

- Ideal zum Schruppfräsen bei Anwendungen mit langer Auskragung und zum Vorschlichten von Gesenken (40-50 HRC).
- Die stabile Konstruktion mit großem Spiralwinkel und 3 Schneiden ermöglicht hohe Schnitttiefen und hohe Vorschubgeschwindigkeiten für erhöhte Bearbeitungseffizienz.

Bestellnummer	Lager	RE	DC	BHTA	APMX	LU	LU_2	B2	DN	LF	DCON	ZEFP	Typ	Effektive Auskragung bei Neigungswinkel			
														30°	1°	2°	3°
MP3XBR0050N008T05	●	0.5	1	0.5°	0.8	8	2.3	9.3°	1.04	60	6	3	1	8.5	8.8	9.3	9.8
MP3XBR0050N012T05	●	0.5	1	0.5°	0.8	12	2.3	7.5°	1.1	60	6	3	1	12.6	13	13.6	14.4
MP3XBR0050N016T05	●	0.5	1	0.5°	0.8	16	2.3	6.3°	1.18	60	6	3	1	16.6	17.1	18	18.9
MP3XBR0050N020T05	●	0.5	1	0.5°	0.8	20	2.3	5.4°	1.24	60	6	3	1	20.6	21.2	22.3	23.5
MP3XBR0050N025T05	●	0.5	1	0.5°	0.8	25	2.3	4.6°	1.34	70	6	3	1	25.7	26.3	27.7	29.3
MP3XBR0050N030T05	●	0.5	1	0.5°	0.8	30	2.3	4°	1.42	70	6	3	1	30.7	31.5	33.1	35
MP3XBR0050N050T05	●	0.5	1	0.5°	0.8	50	2.3	2.6°	1.78	90	6	3	1	50.8	52.1	54.8	*
MP3XBR0050N010T10	●	0.5	1	1°	0.8	10	2.3	8.4°	1.2	60	6	3	1	-	10.6	11.2	11.8
MP3XBR0050N016T10	●	0.5	1	1°	0.8	16	2.3	6.4°	1.42	60	6	3	1	-	16.7	17.6	18.5
MP3XBR0050N020T10	●	0.5	1	1°	0.8	20	2.3	5.5°	1.56	60	6	3	1	-	20.7	21.8	23
MP3XBR0050N025T10	●	0.5	1	1°	0.8	25	2.3	4.7°	1.74	70	6	3	1	-	25.7	27.1	28.6
MP3XBR0050N030T10	●	0.5	1	1°	0.8	30	2.3	4.1°	1.9	70	6	3	1	-	30.8	32.4	34.2
MP3XBR0050N035T10	●	0.5	1	1°	0.8	35	2.3	3.6°	2.08	90	6	3	1	-	35.8	37.7	39.8
MP3XBR0050N050T10	●	0.5	1	1°	0.8	50	2.3	2.7°	2.6	90	6	3	1	-	50.9	53.6	*
MP3XBR0050N010T15	●	0.5	1	1.5°	0.8	10	2.3	8.5°	1.34	60	6	3	1	-	-	11	11.6
MP3XBR0050N016T15	●	0.5	1	1.5°	0.8	16	2.3	6.5°	1.66	60	6	3	1	-	-	17.2	18.1
MP3XBR0050N020T15	●	0.5	1	1.5°	0.8	20	2.3	5.6°	1.86	60	6	3	1	-	-	21.3	22.5
MP3XBR0050N023T15	●	0.5	1	1.5°	0.8	23	2.3	5°	2.02	70	6	3	1	-	-	24.4	25.7
MP3XBR0050N025T15	●	0.5	1	1.5°	0.8	25	2.3	4.7°	2.12	70	6	3	1	-	-	26.5	27.9
MP3XBR0050N010T30	●	0.5	1	3°	0.8	10	2.3	8.8°	1.74	60	6	3	1	-	-	-	10.8
MP3XBR0050N020T30	●	0.5	1	3°	0.8	20	2.3	5.9°	2.8	60	6	3	1	-	-	-	20.9
MP3XBR0050N030T30	●	0.5	1	3°	0.8	30	2.3	4.4°	3.84	70	6	3	1	-	-	-	31
MP3XBR0050N042T30	●	0.5	1	3°	0.8	42	2.3	3.4°	5.1	90	6	3	1	-	-	-	43
MP3XBR0050N025T50	●	0.5	1	5°	0.8	25	2.3	5.4°	4.92	60	6	3	1	-	-	-	-
MP3XBR0075N010T05	●	0.75	1.5	0.5°	1.2	10	2.7	7.8°	1.56	60	6	3	1	10.6	10.9	11.4	12

\* Keine Interferenz

# MP3XB

	RE	DC	BHTA	APMX	LU	LU_2	B2	DN	LF	DCON	ZEFP						
												30'	1°	2°	3°		
MP3XBR0075N016T05	●	0.75	1.5	0.5°	1.2	16	2.7	5.8°	1.68	60	6	3	1	16.6	17.1	17.9	18.9
MP3XBR0075N020T05	●	0.75	1.5	0.5°	1.2	20	2.7	5°	1.74	60	6	3	1	20.6	21.2	22.3	23.5
MP3XBR0075N030T05	●	0.75	1.5	0.5°	1.2	30	2.7	3.7°	1.92	80	6	3	1	30.7	31.5	33.1	35
MP3XBR0075N010T10	●	0.75	1.5	1°	1.2	10	2.7	7.9°	1.7	60	6	3	1	-	10.6	11.2	11.8
MP3XBR0075N016T10	●	0.75	1.5	1°	1.2	16	2.7	5.9°	1.9	60	6	3	1	-	16.7	17.6	18.5
MP3XBR0075N020T10	●	0.75	1.5	1°	1.2	20	2.7	5.1°	2.04	60	6	3	1	-	20.7	21.8	23
MP3XBR0075N030T10	●	0.75	1.5	1°	1.2	30	2.7	3.7°	2.4	80	6	3	1	-	30.8	32.4	34.2
MP3XBR0075N010T15	●	0.75	1.5	1.5°	1.2	10	2.7	8°	1.82	60	6	3	1	-	-	11	11.6
MP3XBR0075N016T15	●	0.75	1.5	1.5°	1.2	16	2.7	6°	2.14	60	6	3	1	-	-	17.2	18.1
MP3XBR0075N020T15	●	0.75	1.5	1.5°	1.2	20	2.7	5.1°	2.34	60	6	3	1	-	-	21.3	22.5
MP3XBR0075N025T15	●	0.75	1.5	1.5°	1.2	25	2.7	4.4°	2.6	80	6	3	1	-	-	26.5	27.9
MP3XBR0075N030T15	●	0.75	1.5	1.5°	1.2	30	2.7	3.8°	2.86	80	6	3	1	-	-	31.6	33.4
MP3XBR0075N046T30	●	0.75	1.5	3°	1.2	46	2.7	2.9°	-	80	6	3	2	-	-	-	*
MP3XBR0100N016T05	●	1	2	0.5°	1.6	16	3.6	5.2°	2.12	60	6	3	1	17	17.6	18.6	19.5
MP3XBR0100N020T05	●	1	2	0.5°	1.6	20	3.6	4.5°	2.18	60	6	3	1	21.1	21.8	22.9	24.1
MP3XBR0100N030T05	●	1	2	0.5°	1.6	30	3.6	3.3°	2.36	70	6	3	1	31.1	32.1	33.7	35.6
MP3XBR0100N035T05	●	1	2	0.5°	1.6	35	3.6	2.9°	2.44	80	6	3	1	36.2	37.2	39.2	*
MP3XBR0100N040T05	●	1	2	0.5°	1.6	40	3.6	2.6°	2.54	80	6	3	1	41.2	42.4	44.6	*
MP3XBR0100N016T10	●	1	2	1°	1.6	16	3.6	5.3°	2.34	60	6	3	1	-	17.1	18.2	19.1
MP3XBR0100N020T10	●	1	2	1°	1.6	20	3.6	4.5°	2.48	60	6	3	1	-	21.2	22.4	23.6
MP3XBR0100N025T10	●	1	2	1°	1.6	25	3.6	3.8°	2.64	70	6	3	1	-	26.2	27.7	29.2
MP3XBR0100N030T10	●	1	2	1°	1.6	30	3.6	3.3°	2.82	70	6	3	1	-	31.3	33	34.8
MP3XBR0100N035T10	●	1	2	1°	1.6	35	3.6	3°	3	80	6	3	1	-	36.3	38.3	40.4
MP3XBR0100N040T10	●	1	2	1°	1.6	40	3.6	2.7°	3.18	80	6	3	1	-	41.3	43.6	*
MP3XBR0100N050T10	●	1	2	1°	1.6	50	3.6	2.2°	3.52	110	6	3	1	-	51.4	54.2	*
MP3XBR0100N070T10	●	1	2	1°	1.6	70	3.6	1.7°	4.22	110	6	3	1	-	71.5	*	*
MP3XBR0100N016T15	●	1	2	1.5°	1.6	16	3.6	5.4°	2.54	60	6	3	1	-	-	22.8	18.7
MP3XBR0100N020T15	●	1	2	1.5°	1.6	20	3.6	4.6°	2.76	60	6	3	1	-	-	21.9	23.1
MP3XBR0100N025T15	●	1	2	1.5°	1.6	25	3.6	3.9°	3.02	70	6	3	1	-	-	27.1	28.5
MP3XBR0100N030T15	●	1	2	1.5°	1.6	30	3.6	3.4°	3.28	70	6	3	1	-	-	32.2	34
MP3XBR0100N035T15	●	1	2	1.5°	1.6	35	3.6	3°	3.54	80	6	3	1	-	-	37.4	39.4
MP3XBR0100N040T15	●	1	2	1.5°	1.6	40	3.6	2.7°	3.8	80	6	3	1	-	-	42.6	*
MP3XBR0100N020T30	●	1	2	3°	1.6	20	3.6	4.8°	3.62	60	6	3	1	-	-	-	20.5
MP3XBR0100N030T30	●	1	2	3°	1.6	30	3.6	3.6°	4.66	70	6	3	1	-	-	-	30.6
MP3XBR0100N042T30	●	1	2	3°	1.6	42	3.6	2.8°	-	80	6	3	2	-	-	-	*
MP3XBR0100N027T50	●	1	2	5°	1.6	27	3.6	4.3°	-	60	6	3	2	-	-	-	-
MP3XBR0150N010T05	●	1.5	3	0.5°	2.4	10	5.4	5.7°	2.98	60	6	3	1	11	11.4	12	12.6
MP3XBR0150N020T05	●	1.5	3	0.5°	2.4	20	5.4	3.5°	3.16	60	6	3	1	21.1	21.8	22.9	24.1
MP3XBR0150N030T05	●	1.5	3	0.5°	2.4	30	5.4	2.6°	3.32	70	6	3	1	31.2	32.1	33.7	*
MP3XBR0150N040T05	●	1.5	3	0.5°	2.4	40	5.4	2°	3.5	80	6	3	1	41.3	42.4	44.6	*
MP3XBR0150N050T05	●	1.5	3	0.5°	2.4	50	5.4	1.7°	3.68	90	6	3	1	51.3	52.7	*	*
MP3XBR0150N020T10	●	1.5	3	1°	2.4	20	5.4	3.6°	3.4	60	6	3	1	-	21.3	22.4	23.6
MP3XBR0150N030T10	●	1.5	3	1°	2.4	30	5.4	2.6°	3.76	70	6	3	1	-	31.3	33	*
MP3XBR0150N035T10	●	1.5	3	1°	2.4	35	5.4	2.3°	3.94	80	6	3	1	-	36.4	38.3	*
MP3XBR0150N040T10	●	1.5	3	1°	2.4	40	5.4	2.1°	4.1	80	6	3	1	-	41.4	43.6	*

\* Keine Interferenz

# MP3XB

		RE	DC	BHTA	APMX	LU	LU_2	B2	DN	LF	DCON	ZEEP					
													30'	1°	2°	3°	
MP3XBR0150N050T10	●	1.5	3	1°	2.4	50	5.4	1.7°	4.46	90	6	3	1	-	51.5	*	*
MP3XBR0150N060T10	●	1.5	3	1°	2.4	60	5.4	1.5°	4.8	110	6	3	1	-	61.5	*	*
MP3XBR0150N070T10	●	1.5	3	1°	2.4	70	5.4	1.3°	5.16	110	6	3	1	-	71.6	*	*
MP3XBR0150N020T15	●	1.5	3	1.5°	2.4	20	5.4	3.7°	3.66	60	6	3	1	-	-	22	23.2
MP3XBR0150N030T15	●	1.5	3	1.5°	2.4	30	5.4	2.7°	4.18	70	6	3	1	-	-	32.3	*
MP3XBR0150N035T15	●	1.5	3	1.5°	2.4	35	5.4	2.4°	4.46	70	6	3	1	-	-	37.5	*
MP3XBR0150N040T15	●	1.5	3	1.5°	2.4	40	5.4	2.1°	4.72	80	6	3	1	-	-	42.6	*
MP3XBR0150N045T15	●	1.5	3	1.5°	2.4	45	5.4	1.9°	4.98	80	6	3	1	-	-	*	*
MP3XBR0150N052T15	●	1.5	3	1.5°	2.4	52	5.4	1.7°	5.34	90	6	3	1	-	-	*	*
MP3XBR0150N064T15	●	1.5	3	1.5°	2.4	64	5.4	1.4°	-	110	6	3	2	-	-	*	*
MP3XBR0150N025T30	●	1.5	3	3°	2.4	25	5.4	3.3°	4.96	60	6	3	1	-	-	-	26.8
MP3XBR0150N034T30	●	1.5	3	3°	2.4	34	5.4	2.6°	-	70	6	3	2	-	-	-	*
MP3XBR0150N040T30	●	1.5	3	3°	2.4	40	5.4	3.4°	6.52	90	8	3	1	-	-	-	41.9
MP3XBR0150N054T30	●	1.5	3	3°	2.4	54	5.4	2.7°	-	90	8	3	2	-	-	-	*
MP3XBR0200N030T05	●	2	4	0.5°	3.2	30	6.2	1.8°	4.32	70	6	3	1	31.2	32.1	*	*
MP3XBR0200N040T05	●	2	4	0.5°	3.2	40	6.2	1.4°	4.48	80	6	3	1	41.3	42.4	*	*
MP3XBR0200N060T05	●	2	4	0.5°	3.2	60	6.2	1°	4.84	100	6	3	1	61.4	63	*	*
MP3XBR0200N020T10	●	2	4	1°	3.2	20	6.2	2.6°	4.38	70	6	3	1	-	21.3	22.4	*
MP3XBR0200N030T10	●	2	4	1°	3.2	30	6.2	1.8°	4.74	70	6	3	1	-	31.4	*	*
MP3XBR0200N035T10	●	2	4	1°	3.2	35	6.2	1.6°	4.9	70	6	3	1	-	36.4	*	*
MP3XBR0200N040T10	●	2	4	1°	3.2	40	6.2	1.5°	5.08	80	6	3	1	-	41.4	*	*
MP3XBR0200N045T10	●	2	4	1°	3.2	45	6.2	1.3°	5.26	80	6	3	1	-	46.5	*	*
MP3XBR0200N066T10	●	2	4	1°	3.2	66	6.2	1°	-	100	6	3	2	-	*	*	*
MP3XBR0200N050T15	●	2	4	1.5°	3.2	50	6.2	2.2°	6.2	90	8	3	1	-	-	53	*
MP3XBR0200N084T15	●	2	4	1.5°	3.2	84	6.2	1.5°	-	120	8	3	2	-	-	*	*
MP3XBR0200N030T30	●	2	4	3°	3.2	30	6.2	3.6°	6.4	90	8	3	1	-	-	-	31.9
MP3XBR0200N045T30	●	2	4	3°	3.2	45	6.2	2.6°	-	90	8	3	2	-	-	-	*
MP3XBR0250N038T10	●	2.5	5	1°	4	38	7	0.8°	-	80	6	3	2	-	*	*	*
MP3XBR0250N050T10	●	2.5	5	1°	4	50	7	1.7°	6.4	90	8	3	1	-	51.5	*	*
MP3XBR0250N065T10	●	2.5	5	1°	4	65	7	1.4°	6.92	110	8	3	1	-	66.6	*	*
MP3XBR0250N066T15	●	2.5	5	1.5°	4	66	7	1.4°	-	110	8	3	2	-	-	*	*
MP3XBR0250N036T30	●	2.5	5	3°	4	36	7	2.4°	-	90	8	3	2	-	-	-	*
MP3XBR0300N040T10	●	3	6	1°	9	40	12	1.4°	6.82	80	8	3	1	-	41.8	*	*
MP3XBR0300N050T10	●	3	6	1°	9	50	12	1.2°	7.18	90	8	3	1	-	51.8	*	*
MP3XBR0300N073T10	●	3	6	1°	9	73	12	0.9°	-	110	8	3	2	-	*	*	*
MP3XBR0300N090T10	●	3	6	1°	9	90	12	1.3°	8.58	140	10	3	1	-	92	*	*
MP3XBR0300N053T15	●	3	6	1.5°	9	53	12	1.2°	-	90	8	3	2	-	-	*	*
MP3XBR0300N032T30	●	3	6	3°	9	32	12	1.9°	-	80	8	3	2	-	-	-	*
MP3XBR0400N050T10	●	4	8	1°	12	50	15	1.2°	9.08	110	10	3	1	-	51.9	*	*
MP3XBR0400N065T10	●	4	8	1°	12	65	15	1°	9.6	130	10	3	1	-	67	*	*
MP3XBR0400N076T10	●	4	8	1°	12	76	15	0.8°	-	130	10	3	2	-	*	*	*
MP3XBR0400N090T10	●	4	8	1°	12	90	15	1.3°	10.46	150	12	3	1	-	92.1	*	*
MP3XBR0400N040T15	●	4	8	1.5°	12	40	15	1.5°	9.16	90	10	3	1	-	-	*	*
MP3XBR0400N056T15	●	4	8	1.5°	12	56	15	1.1°	-	110	10	3	2	-	-	*	*
MP3XBR0400N035T30	●	4	8	3°	12	35	15	1.7°	-	90	10	3	2	-	-	-	*
MP3XBR0500N060T10	●	5	10	1°	15	60	25	1°	10.92	120	12	3	1	-	62.6	*	*
MP3XBR0500N070T10	●	5	10	1°	15	70	25	0.9°	11.28	120	12	3	1	-	*	*	*
MP3XBR0500N100T10	●	5	10	1°	15	100	25	1.7°	12.32	160	16	3	1	-	102.8	*	*
MP3XBR0500N050T15	●	5	10	1.5°	15	50	25	1.2°	11	100	12	3	1	-	-	*	*

\* Keine Interferenz

# MP3XB

Bestellnummer	Lager	RE	DC	BHTA	APMX	LU	LU_2	B2	DN	LF	DCON	ZEFP	Typ	Effektive Auskrägung bei Neigungswinkel			
														30'	1°	2°	3°
MP3XBR0500N068T15	●	5	10	1.5°	15	68	25	0.9°	-	120	12	3	2	-	-	*	*
MP3XBR0500N046T30	●	5	10	3°	15	46	25	1.3°	-	100	12	3	2	-	-	-	*
MP3XBR0600N070T10	●	6	12	1°	18	70	28	1.6°	13.16	130	16	3	1	-	72.7	*	*
MP3XBR0600N100T10	●	6	12	1°	18	100	28	1.2°	14.22	160	16	3	1	-	102.9	*	*
MP3XBR0600N080T15	●	6	12	1.5°	18	80	28	1.5°	14.42	130	16	3	1	-	-	*	*
MP3XBR0600N069T30	●	6	12	3°	18	69	28	1.8°	-	130	16	3	2	-	-	-	*

\* Keine Interferenz

# MP3XB

## SCHNITTDATENEMPFEHLUNGEN

### 3D FRÄSEN

Material	RE	BHTA	LU	n	Vf	ap	ae	
P C-Stahl, Gusseisen (180 – 280 HB) Werkzeugstahl (<350 HB) Vergüteter Stahl (35 – 45 HRC)	R 0.5	0.5°	8	40000	1200	0.07	0.22	
			12	40000	1200	0.06	0.19	
			16	35000	1100	0.06	0.18	
			20	32000	960	0.05	0.14	
			25	28000	830	0.03	0.11	
			30	24000	720	0.03	0.1	
	50	10000	300	0.003	0.015			
	R 0.5	1°	10	40000	1200	0.07	0.22	
			16	35000	1100	0.06	0.18	
			20	32000	960	0.05	0.14	
			25	28000	830	0.04	0.11	
			30	24000	720	0.03	0.1	
			35	17000	500	0.03	0.08	
	R 0.5	1.5°	50	10000	300	0.003	0.015	
			10	40000	1200	0.07	0.22	
			16	35000	1100	0.06	0.18	
			20	32000	960	0.05	0.14	
			23	27000	830	0.04	0.11	
			25	27000	830	0.04	0.12	
	R 0.75	3°	10	40000	1200	0.07	0.22	
			20	32000	960	0.05	0.14	
			30	22000	660	0.03	0.1	
			42	13000	390	0.005	0.02	
			5°	25	32000	960	0.04	0.11
			R 0.75	0.5°	10	30000	1800	0.11
	16	27000			1600	0.09	0.27	
	20	26000			1500	0.08	0.24	
	30	25000			1400	0.07	0.21	
	1°	10		30000	1900	0.11	0.34	
		16		26000	1600	0.09	0.27	
20		27000		1700	0.08	0.24		
30		25000		1500	0.07	0.21		
1.5°	10	30000		1900	0.11	0.34		
	16	27500		1700	0.09	0.27		
	20	26500		1700	0.08	0.24		
	25	26000		1600	0.07	0.22		
30	25000	1500	0.07	0.21				
3°	46	15000	450	0.05	0.16			

# MP3XB

Material	RE	BHTA	LU	n	Vf	ap	ae							
N Kupfer, Kupferlegierungen			0.5°	8	39000	1200	0.12	0.38						
				12	39000	1200	0.1	0.32						
				16	33000	900	0.09	0.29						
				20	29000	800	0.07	0.22						
				25	24000	600	0.05	0.15						
				30	21000	450	0.04	0.13						
			R 0.5			1°	50	11000	150	0.006	0.019			
							10	39000	1300	0.12	0.38			
							16	33000	1000	0.09	0.29			
							20	29000	900	0.07	0.22			
							25	24000	700	0.05	0.16			
							30	21000	550	0.04	0.13			
						1.5°				35	13000	350	0.03	0.1
										50	11000	250	0.006	0.019
										10	39000	1400	0.12	0.38
										16	33000	1100	0.09	0.29
										20	29000	1000	0.07	0.22
										23	24000	800	0.05	0.16
			3°				25	24000	800	0.05	0.17			
							10	39000	1500	0.12	0.38			
							20	29000	1100	0.07	0.22			
							30	19000	700	0.04	0.13			
							42	11000	390	0.01	0.03			
							5°	25	29000	1000	0.05	0.16		
			R 0.75			0.5°	10	28000	1500	0.19	0.61			
							16	24000	1100	0.15	0.48			
							20	24000	1100	0.13	0.42			
							30	22000	1000	0.11	0.35			
						1°				10	28000	1600	0.19	0.61
										16	24000	1200	0.15	0.48
20	24000	1200								0.13	0.42			
30	22000	1100								0.11	0.35			
1.5°							10	28000	1700	0.19	0.61			
							16	24000	1300	0.15	0.48			
							20	24000	1300	0.13	0.42			
							25	23000	1200	0.12	0.38			
3°				30	22000	1100	0.11	0.35						
				46	14000	800	0.08	0.26						

# MP3XB

Material	RE	BHTA	LU	n	Vf	ap	ae
H Gehärteter Stahl (45-55 HRC)	R 0.5	0.5°	8	39000	1200	0.06	0.19
			12	39000	1200	0.05	0.16
			16	33000	900	0.04	0.14
			20	29000	800	0.04	0.11
			25	24000	600	0.02	0.07
			30	21000	450	0.02	0.06
			50	11000	150	0.003	0.015
		1°	10	39000	1300	0.06	0.19
			16	33000	1000	0.05	0.14
			20	29000	900	0.04	0.11
			25	24000	700	0.03	0.08
			30	21000	550	0.02	0.06
			35	13000	350	0.02	0.05
			50	11000	250	0.003	0.015
			1.5°	10	39000	1400	0.06
	16	33000		1100	0.05	0.14	
	20	29000		1000	0.04	0.11	
	23	24000		800	0.03	0.08	
	25	24000		800	0.03	0.09	
	3°	10	39000	1500	0.06	0.19	
		20	29000	1100	0.04	0.11	
		30	19000	700	0.02	0.06	
		42	11000	390	0.005	0.02	
	5°	25	29000	1000	0.03	0.08	
	R 0.75	0.5°	10	28000	1500	0.1	0.3
			16	24000	1100	0.08	0.24
			20	24000	1100	0.07	0.21
			30	22000	1000	0.06	0.18
			10	28000	1600	0.1	0.3
		1°	16	24000	1200	0.08	0.24
20			24000	1200	0.07	0.21	
30			22000	1100	0.06	0.18	
10			28000	1700	0.1	0.3	
1.5°		16	24000	1300	0.08	0.24	
		20	24000	1300	0.07	0.21	
		25	23000	1200	0.06	0.19	
		30	22000	1100	0.06	0.18	
3°		46	14000	800	0.04	0.13	

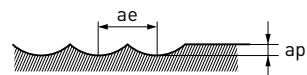



# MP3XB

## 3D FRÄSEN

Material	RE	BHTA	LU	n	Vf	ap	ae
C-Stahl, Gusseisen (180 – 280 HB) Werkzeugstahl (<350 HB) Vergüteter Stahl (35 – 45 HRC)	R 1.0	0.5°	16	25000	1500	0.14	0.45
			20	23000	1400	0.1	0.3
			30	20000	1200	0.05	0.17
			35	19000	1100	0.05	0.15
			40	19000	1100	0.04	0.14
		1°	16	25000	2300	0.14	0.45
			20	23000	2100	0.1	0.3
			25	23000	1400	0.06	0.19
			30	20000	1200	0.05	0.17
			35	19000	1100	0.05	0.15
		1.5°	40	19000	1100	0.04	0.14
			50	17000	900	0.03	0.09
			70	13000	700	0.02	0.06
			16	25000	2300	0.14	0.45
			20	23000	2100	0.1	0.3
	3°	25	23000	1600	0.06	0.19	
		30	20000	1200	0.05	0.17	
		35	19000	1100	0.05	0.15	
		40	19000	1100	0.04	0.14	
		20	23000	2100	0.1	0.3	
	5°	30	18000	1600	0.08	0.26	
		42	16000	1400	0.07	0.21	
		27	18000	2200	0.09	0.29	
		10	20000	2400	0.22	0.7	
		20	17000	2000	0.2	0.64	
	R 1.5	0.5°	30	16000	1700	0.14	0.45
			40	16000	1400	0.08	0.24
			50	13000	1100	0.06	0.2
			20	17000	2000	0.2	0.64
			30	17000	1900	0.14	0.45
1°		35	16000	1700	0.08	0.26	
		40	16000	1500	0.08	0.24	
		50	13000	1200	0.06	0.2	
		60	13000	1100	0.06	0.19	
		70	10000	800	0.05	0.17	
1.5°	0.5°	20	17000	2000	0.2	0.64	
		30	16000	1800	0.14	0.45	
		35	15000	1700	0.08	0.26	
		40	15000	1600	0.08	0.24	
		45	13000	1400	0.07	0.22	
	1°	52	13000	1300	0.06	0.2	
		64	10000	900	0.06	0.18	
		25	16000	2400	0.16	0.51	
		34	14000	2100	0.13	0.4	
		40	14000	1700	0.12	0.37	
3°	54	12000	1400	0.1	0.3		

# MP3XB

Material	RE	BHTA	LU	n	Vf	ap	ae
N Kupfer, Kupferlegierungen	R 1.0	0.5°	16	22000	1600	0.26	0.83
			20	20000	1400	0.17	0.54
			30	18000	1100	0.13	0.42
			35	17000	1000	0.12	0.38
			40	16000	900	0.11	0.35
		1°	16	22000	1700	0.26	0.83
			20	20000	1500	0.17	0.54
			25	20000	1300	0.16	0.5
			30	18000	1200	0.13	0.42
			35	17000	1100	0.12	0.37
		1.5°	40	16000	1000	0.11	0.35
			50	15000	900	0.06	0.19
			70	11000	650	0.04	0.12
			16	22000	1800	0.26	0.83
			20	20000	1600	0.17	0.54
	3°	25	20000	1400	0.16	0.5	
		30	18000	1300	0.13	0.42	
		35	17000	1100	0.12	0.38	
		40	16000	1000	0.11	0.35	
		20	20000	1700	0.17	0.54	
	5°	30	16500	1300	0.14	0.45	
		42	13000	1000	0.11	0.35	
		27	17000	1900	0.16	0.51	
		10	17000	1900	0.42	1.34	
		20	15000	1600	0.38	1.22	
	R 1.5	0.5°	30	13000	1400	0.26	0.83
			40	12000	1200	0.2	0.65
			50	11000	1100	0.17	0.54
			20	15000	1800	0.38	1.22
			30	13000	1500	0.26	0.83
1°		35	13000	1500	0.22	0.69	
		40	13000	1300	0.2	0.65	
		50	11000	1100	0.17	0.54	
		60	11000	1000	0.16	0.5	
		70	9000	700	0.13	0.42	
1.5°		20	15000	1900	0.38	1.22	
		30	13000	1600	0.26	0.83	
		35	12000	1400	0.22	0.69	
		40	12000	1300	0.2	0.65	
		45	11000	1300	0.18	0.58	
3°	52	11000	1100	0.17	0.54		
	64	9000	900	0.14	0.46		
	25	13000	1900	0.3	0.96		
	34	11000	1600	0.23	0.74		
	40	11000	1400	0.21	0.67		
54	10000	1200	0.17	0.54			

# MP3XB

Material	RE	BHTA	LU	n	Vf	ap	ae
H Gehärteter Stahl (45-55 HRC)	R 1.0	0.5°	16	22000	1600	0.13	0.42
			20	20000	1400	0.09	0.27
			30	18000	1100	0.06	0.18
			35	17000	1000	0.05	0.16
			40	16000	900	0.05	0.14
			16	22000	1700	0.13	0.42
		20	20000	1500	0.09	0.27	
		25	20000	1300	0.07	0.21	
		30	18000	1200	0.06	0.18	
		35	17000	1100	0.05	0.15	
		40	16000	1000	0.05	0.14	
		50	15000	900	0.03	0.08	
		70	11000	650	0.02	0.05	
		1.5°	16	22000	1800	0.13	0.42
			20	20000	1600	0.09	0.27
			25	20000	1400	0.07	0.21
			30	18000	1300	0.06	0.18
			35	16000	1100	0.05	0.16
	40		16000	1000	0.05	0.14	
	3°	20	20000	1700	0.09	0.27	
		30	16000	1300	0.07	0.22	
		42	13000	1000	0.06	0.18	
	5°	27	17000	1900	0.08	0.26	
	R 1.5	0.5°	10	17000	1900	0.21	0.67
			20	15000	1600	0.19	0.61
			30	13000	1400	0.13	0.42
			40	12000	1200	0.09	0.27
			50	11000	1100	0.07	0.22
			20	15000	1800	0.19	0.61
		1°	30	13000	1500	0.13	0.42
			35	13000	1500	0.09	0.29
			40	13000	1300	0.09	0.27
			50	11000	1100	0.07	0.22
			60	11000	1000	0.07	0.21
			70	9000	700	0.06	0.18
		1.5°	20	15000	1900	0.19	0.61
30			13000	1600	0.13	0.42	
35			12000	1400	0.09	0.29	
40			12000	1300	0.09	0.27	
45			11000	1300	0.08	0.24	
52			11000	1100	0.07	0.22	
3°	64	9000	900	0.06	0.19		
	25	13000	1900	0.15	0.48		
	34	11000	1600	0.12	0.37		
	40	11000	1400	0.11	0.34		
	54	10000	1200	0.09	0.27		

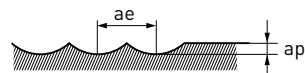

# MP3XB

## 3D FRÄSEN

Material RE BHTA LU n Vf ap ae

Material	RE	BHTA	LU	n	Vf	ap	ae	
C-Stahl, Gusseisen (180 – 280 HB) Werkzeugstahl (<350 HB) Vergüteter Stahl (35 – 45 HRC)	R 2.0	0.5°	30	14000	2100	0.23	0.74	
			40	12000	1800	0.19	0.61	
			60	9000	1300	0.06	0.19	
		R 2.0	1°	20	15000	2700	0.31	0.99
				30	14000	2100	0.23	0.74
				35	12000	1800	0.21	0.67
				40	12000	1700	0.19	0.61
			1.5°	45	12000	1500	0.13	0.42
				66	9000	1100	0.08	0.24
	50			12000	2200	0.11	0.35	
	84			8000	1400	0.04	0.13	
	3°			30	14000	2500	0.23	0.74
	R 2.5	1°	45	11000	1900	0.16	0.51	
			38	10000	2200	0.28	0.9	
		1.5°	50	9000	1900	0.24	0.77	
			65	8000	1600	0.16	0.51	
		3°	66	8000	1600	0.16	0.51	
			36	10000	2700	0.31	0.99	
	R 3.0	1°	40	8000	2200	0.28	0.9	
			50	8000	2000	0.23	0.74	
			73	7000	1700	0.15	0.48	
		1.5°	90	6500	1500	0.09	0.29	
			53	7000	2100	0.22	0.7	
		3°	32	9000	2400	0.35	1.12	
	R 4.0	1°	50	6000	2200	0.41	1.31	
			65	6000	2000	0.36	1.15	
			76	6000	1800	0.29	0.93	
1.5°		90	5000	1400	0.19	0.61		
		40	6000	2300	0.46	1.47		
		56	6000	2200	0.38	1.22		
3°	35	7000	2700	0.49	1.57			
R 5.0	1°	60	5500	2600	0.51	1.63		
		70	5500	2600	0.46	1.47		
		100	5000	2400	0.36	1.15		
	1.5°	50	5000	2400	0.56	1.79		
		68	5000	2400	0.49	1.57		
		46	5000	2400	0.69	2.21		
R 6.0	1°	70	4500	2600	0.81	2.59		
		100	4000	2200	0.61	1.95		
	1.5°	80	5000	2300	0.71	2.27		
		69	5000	2700	0.81	2.59		

# MP3XB

Material	RE	BHTA	LU	n	Vf	ap	ae	
N Kupfer, Kupferlegierungen	R 2.0	0.5°	30	11000	1800	0.44	1.41	
			40	10000	1600	0.36	1.15	
			60	8500	1400	0.16	0.5	
		R 2.0	1°	20	12000	2200	0.72	2.3
				30	11000	1800	0.53	1.69
				35	10000	1700	0.48	1.54
				40	10000	1600	0.43	1.38
				45	10000	1600	0.29	0.92
				66	8500	1300	0.16	0.5
	1.5°		50	10000	1700	0.24	0.77	
			84	6500	900	0.07	0.23	
			3°	30	11000	2000	0.53	1.69
	45	9000		1600	0.36	1.15		
	R 2.5	1°		38	8500	2000	0.65	2.07
			50	8000	1800	0.55	1.77	
			65	6500	1400	0.36	1.15	
		1.5°	66	6500	1500	0.36	1.15	
		3°	36	8500	2300	0.72	2.3	
	R 3.0	1°	40	7500	2100	0.65	2.07	
			50	6500	1800	0.53	1.69	
			73	6500	1700	0.34	1.07	
			90	6000	1300	0.19	0.61	
		1.5°	53	6500	1900	0.5	1.61	
		3°	32	8000	2200	0.82	2.61	
		R 4.0	1°	50	5500	2000	0.96	3.07
	65			5200	1700	0.84	2.69	
	76			5000	1500	0.67	2.15	
	90			4700	1200	0.43	1.38	
	1.5°		40	5800	2200	1.08	3.46	
			56	5500	2000	0.9	2.84	
3°			35	6000	2400	1.15	3.69	
			R 5.0	1°	60	4500	2300	1.2
	70	4500			2200	1.08	3.46	
100	4000	1900			0.84	2.69		
1.5°	50	4600		2400	1.32	4.22		
	68	4600		2300	1.15	3.69		
3°	46	4800	2500	1.63	5.22			
R 6.0	1°	70	4000	2100	1.92	6.14		
		100	3500	1800	1.44	4.61		
	1.5°	80	4000	2000	1.68	5.38		
	3°	69	4000	2200	1.92	6.14		

# MP3XB

Material	RE	BHTA	LU	n	Vf	ap	ae
H Gehärteter Stahl (45-55 HRC)	R 2.0	0.5°	30	11000	1800	0.22	0.7
			40	10000	1600	0.18	0.58
			60	8500	1400	0.07	0.21
		1°	20	12000	2200	0.3	0.96
			30	11000	1800	0.22	0.7
			35	10000	1700	0.2	0.64
			40	10000	1600	0.18	0.58
			45	10000	1600	0.12	0.38
			66	8500	1300	0.07	0.21
	1.5°		50	10000	1700	0.1	0.32
			84	6500	900	0.03	0.1
			3°	30	11000	2000	0.22
	45	9000		1600	0.15	0.48	
	R 2.5	1°		38	8500	2000	0.27
			50	8000	1800	0.23	0.74
			65	6500	1400	0.15	0.48
		1.5°	66	6500	1500	0.15	0.48
		3°	36	8500	2300	0.3	0.96
	R 3.0	1°	40	7500	2100	0.27	0.86
			50	6500	1800	0.22	0.7
			73	6500	1700	0.14	0.45
		1.5°	90	6000	1300	0.08	0.26
			53	6500	1900	0.21	0.67
		3°	32	8000	2200	0.34	1.09
		R 4.0	1°	50	5500	2000	0.4
	65			5200	1700	0.35	1.12
	76			5000	1500	0.28	0.9
	1.5°		90	4700	1200	0.18	0.58
			40	5800	2200	0.45	1.44
			56	5500	2000	0.37	1.18
3°			35	6000	2400	0.48	1.54
R 5.0	1°	60	4500	2300	0.5	1.6	
		70	4500	2200	0.45	1.44	
		100	4000	1900	0.35	1.12	
	1.5°	50	4600	2400	0.55	1.76	
		68	4600	2300	0.48	1.54	
		3°	46	4800	2500	0.68	2.18
R 6.0	1°	70	4000	2100	0.8	2.56	
		100	3500	1800	0.6	1.92	
	1.5°	80	4000	2000	0.7	2.24	
	3°	69	4000	2200	0.8	2.56	

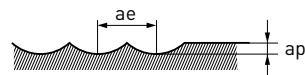

1. Bei geringen Schnitttiefen können Drehzahl und Vorschub erhöht werden.
2. Falls die Stabilität der Maschine oder der Werkstückbefestigung sehr gering ist oder Vibrationen auftreten, müssen Drehzahl und Vorschub entsprechend reduziert werden.

**NEW**

# MP3C

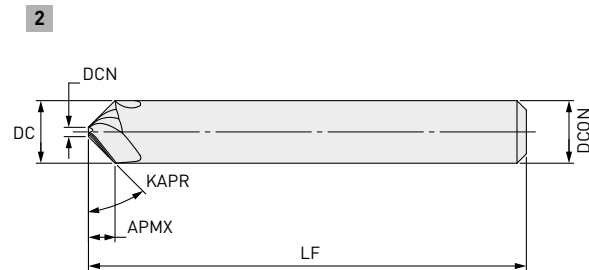
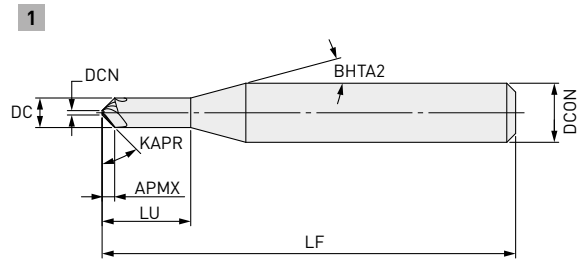

## FASFRÄSER, 3-SCHNEIDIG

**P M S H**

DCN

± 0.03



	DCON=6	8<DCON<=10	DCON=12
h6	0	0	0
	-0.008	-0.009	-0.011

- Die geschwungene Schneidkante bietet eine gute Schärfe und verhindert effektiv das Auftreten von Grat.
- Bearbeitung mit hohem Tischvorschub durch Verwendung von 3 Schneiden.

Bestellnummer	Lager	DC	APMX	LU	LF	DCON	ZEFP	DCN	Typ
MP3CD0200	●	2	0.85	6	50	6	3	0.3	1
MP3CD0400	●	4	1.85	12	50	6	3	0.3	1
MP3CD0600	●	6	2.85	—	50	6	3	0.3	2
MP3CD0800	●	8	3.8	—	60	8	3	0.4	2
MP3CD1000	●	10	4.75	—	70	10	3	0.5	2
MP3CD1200	●	12	5.75	—	75	12	3	0.5	2

88

# MP3C

## SCHNITTDATENEMPFEHLUNGEN

### ECKEN- UND FASFRÄSEN BOHR- / KONTURUMFANG

Material	DC	Vc	n	Vf	Kontur- umfang	ap	
						Kontur- umfang	Bohr- umfang
P C-Stahl, Duktiles Gusseisen, unlegierter Stahl (C≥0,55 %)	2	100	16000	1400	≤ 0.6	≤ 0.4	
	4	100	8000	720	≤ 1.2	≤ 0.8	
	6	100	5300	480	≤ 1.8	≤ 1.2	
	8	100	4000	360	≤ 2.4	≤ 1.6	
	10	100	3200	290	≤ 2.5	≤ 2.0	
	12	100	2700	240	≤ 2.5	≤ 2.4	
	Legierter Stahl (325HB) (38-45HRC)	2	70	11000	890	≤ 0.6	≤ 0.4
		4	70	5600	450	≤ 1.2	≤ 0.8
		6	70	3700	300	≤ 1.8	≤ 1.2
		8	70	2800	230	≤ 2.4	≤ 1.6
		10	70	2200	180	≤ 2.5	≤ 2.0
	M Austenitische rostfreie Stähle, Titanlegierungen	2	60	9500	680	≤ 0.6	≤ 0.4
4		60	4800	350	≤ 1.2	≤ 0.8	
6		60	3200	230	≤ 1.8	≤ 1.2	
8		60	2400	170	≤ 2.4	≤ 1.6	
10		60	1900	140	≤ 2.5	≤ 2.0	
S Gehärteter Stahl (45-55HRC)	2	50	8000	480	≤ 0.6	≤ 0.4	
	4	50	4000	240	≤ 1.2	≤ 0.8	
	6	50	2700	160	≤ 1.8	≤ 1.2	
	8	50	2000	120	≤ 2.4	≤ 1.6	
	10	50	1600	96	≤ 2.5	≤ 2.0	
H	12	50	1300	78	≤ 2.5	≤ 2.4	

1. Bei austenitischem rostfreiem Stahl ist die Verwendung eines wasserlöslichen Kühlmittels effektiv.
2. Drehzahl und Vorschub können bei geringerer Schnitttiefe erhöht werden.
3. Bei geringer Stabilität der Maschine oder des Werkstückmaterials können Vibrationen auftreten.  
In diesem Fall müssen Drehzahl und Vorschub proportional verringert werden.



## MP3C

### V-NUTEN

Material	DC	Vc	n	Vf	ap	
P C-Stahl, Duktiles Gusseisen, unlegierter Stahl (C>0,55 %)	2	80	13000	940	≤ 1.4	
	4	80	6400	460	≤ 2.8	
	6	80	4200	300	≤ 4.2	
	8	80	3200	230	≤ 5.6	
	10	80	2500	180	≤ 7.0	
	12	80	2100	150	≤ 8.4	
	Legierter Stahl (325HB) (38-45HRC)	2	60	9500	620	≤ 1.4
		4	60	4800	310	≤ 2.8
		6	60	3200	210	≤ 4.2
		8	60	2400	160	≤ 5.6
		10	60	1900	120	≤ 7.0
		12	60	1600	100	≤ 8.4
M Austenitische rostfreie Stähle, Titanlegierungen	2	50	8000	460	≤ 1.4	
	4	50	4000	230	≤ 2.8	
	6	50	2700	160	≤ 4.2	
	8	50	2000	120	≤ 5.6	
	10	50	1600	92	≤ 7.0	
S Gehärteter Stahl (45-55HRC)	12	50	1300	75	≤ 8.4	
	2	40	6400	310	≤ 1.4	
	4	40	3200	150	≤ 2.8	
	6	40	2100	100	≤ 4.2	
	8	40	1600	77	≤ 5.6	
	10	40	1300	62	≤ 7.0	
	12	40	1100	53	≤ 8.4	

1. Bei austenitischem rostfreiem Stahl ist die Verwendung eines wasserlöslichen Kühlmittels effektiv.
2. Drehzahl und der Vorschub können bei geringerer Schnitttiefe erhöht werden.
3. Bei geringer Stabilität der Maschine oder des Werkstückmaterials können Vibrationen auftreten.  
In diesem Fall müssen Drehzahl und Vorschub proportional verringert werden.

# MS PLUS

## ANWENDUNGSBEISPIELE

### C-STAHL

MS Plus bietet bei der Bearbeitung von C-Stahl eine ausgezeichnete Verschleißfestigkeit und bedeutend längere Werkzeugstandzeiten im Vergleich zu konventionellen Produkten.

Werkstoff	1.0535
Werkzeug	2-schneidiger Kugelkopfräser R3
n (min <sup>-1</sup> )	16.000
Vc (m/min)	284
Vf (mm/min)	2.000
fz (mm/Zahn)	0.06
ap (mm)	2
ae (mm)	0.3
Auskragung (mm)	20
Schnittmodus	Gleichlauf
Kühlung	Druckluft
Maschine	Horizontal M/C (BT40)

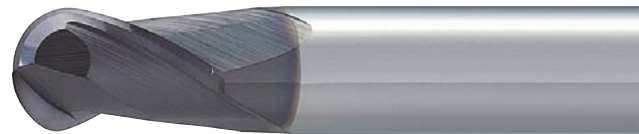
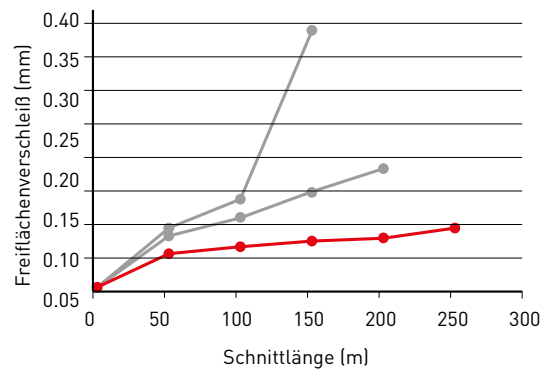

### LEGIERTER STAHL, WERKZEUGSTAHL

MS Plus zeigt eine höhere Verschleißfestigkeit als konventionelle Produkte bei der Bearbeitung von SKD61 (52 HRC). IMPACT MIRACLE wird empfohlen, wenn eine noch längere Standzeit erforderlich ist.

Werkstoff	1.2344
Werkzeug	2-schneidiger Kugelkopfräser R3
n (min <sup>-1</sup> )	17.000
Vc (m/min)	300
Vf (mm/min)	1.700
fz (mm/Zahn)	0.05
ap (mm)	2
ae (mm)	0.3
Auskragung (mm)	20
Schnittmodus	Gleichlauf
Kühlung	Druckluft
Maschine	Horizontal M/C (BT40)

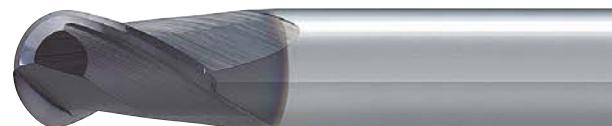
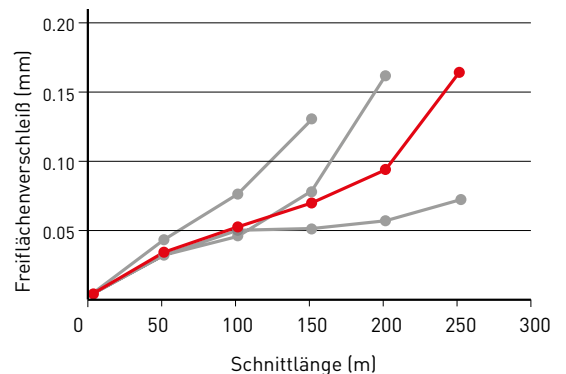

■ : MP2MB ■ A ■ B ■ C : Herkömmliches Werkzeug

# ANWENDUNGSBEISPIELE

## GEHÄRTETER WERKZEUGSTAHL (52 HRC)

Die MS Plus Serie zeigt im Vergleich zu herkömmlichen VHM-Fräsern einen deutlich höheren Verschleißwiderstand bei der Bearbeitung von gehärtetem Werkzeugstahl.

Werkstoff	1.2083
Werkzeug	2-schneidiger Kugelkopffräser R3
n (min <sup>-1</sup> )	18.000
Vc (m/min)	169
Vf (mm/min)	3.600
fz (mm/Zahn)	0.1
ap (mm)	0.4
ae (mm)	1
Auskragung (mm)	20
Schnittmodus	Gleichlauf
Kühlung	Druckluft
Maschine	Horizontal M/C (BT40)

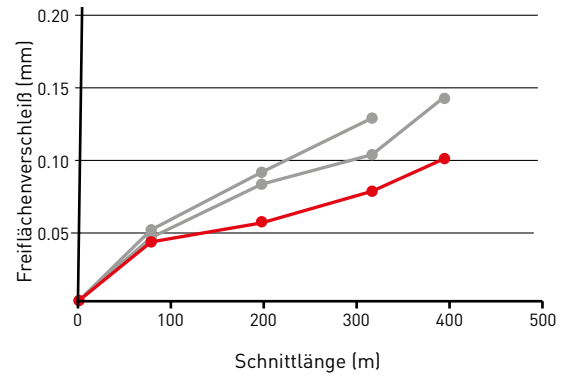

## KUPFER

MS Plus ermöglicht einen vielseitigen Einsatz in unterschiedlichsten Werkstoffen. Auch bei der Bearbeitung von Kupferlegierungen werden ausgezeichnete Standzeiten bei produktiven Zerspanungsraten erzielt.

Werkstoff	Kupfer
Werkzeug	2-schneidiger Kugelkopffräser R3
n (min <sup>-1</sup> )	15.000
Vc (m/min)	267
Vf (mm/min)	1.500
fz (mm/Zahn)	0.05
ap (mm)	2
ae (mm)	0.2
Auskragung (mm)	20
Schnittmodus	Gleichlauf
Kühlung	Emulsion
Maschine	Vertikal M/C (BT40)

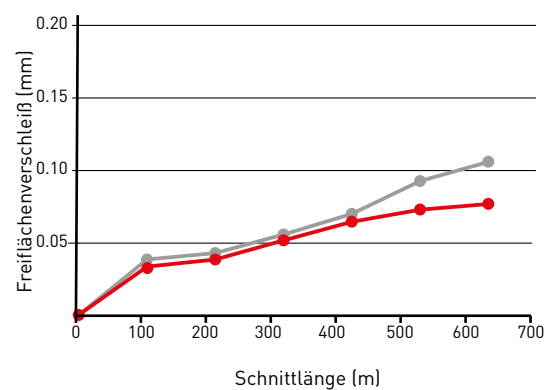

■ : MP2MB ■ A ■ B : Herkömmliches Werkzeug

# ANWENDUNGSBEISPIELE

## BRUCHFESTIGKEIT

MP2SDB bietet eine hervorragende Bruchfestigkeit auch bei der Anwendung mit großen Schnitttiefen, hohen Vorschubgeschwindigkeiten und langen Auskragungen.

Werkstoff	1.2344
Werkzeug	MP2SDBR0500
n (min <sup>-1</sup> )	5.000
Vc (m/min)	157
Vf (mm/min)	1.000
fz (mm/Zahn)	0.1
ap (mm)	5.0
ae (mm)	3.0
Auskragung (mm)	50
Schnittmodus	Gleichlauf
Kühlung	Druckluft
Maschine	Vertikal MC (BT50)

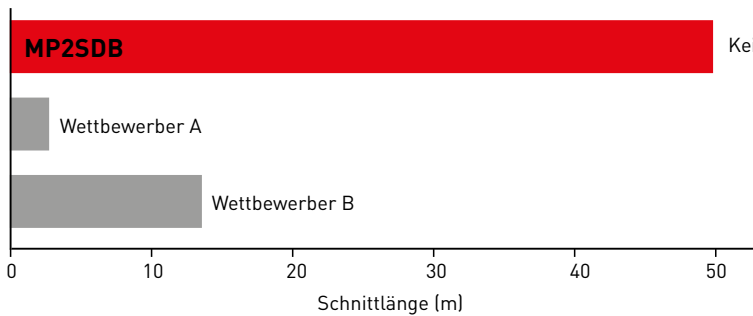
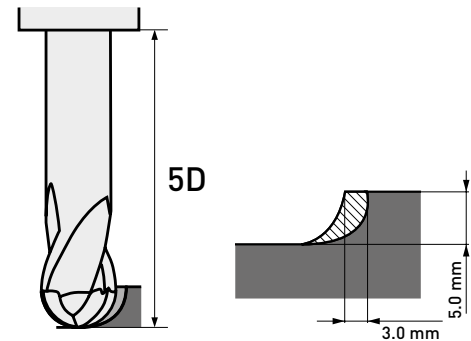

## HOHE BRUCHFESTIGKEIT BEI LANGEN AUSKRAGUNGEN

Hohe Zuverlässigkeit in der Schruppbearbeitung, selbst bei Anwendungen mit langer Auskragungen.

Werkstoff	1.2344
Werkzeug	MP3XBR0200N040T10
n (min <sup>-1</sup> )	7.500
Vc (m/min)	94
Vf (mm/min)	2.600
fz (mm/Zahn)	0.12
ap (mm)	2
ae (mm)	0.4
Auskragung (mm)	40
Schnittmodus	Gleichlauf
Kühlung	Druckluft
Maschine	Vertikal MC (BT50)

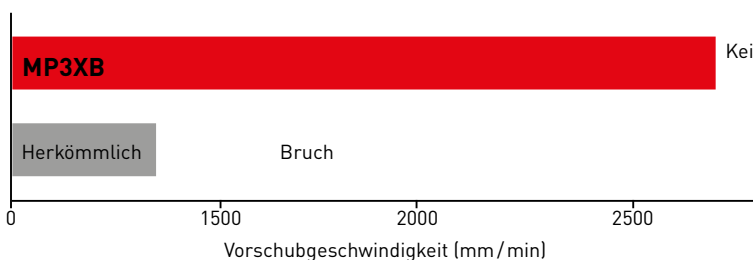
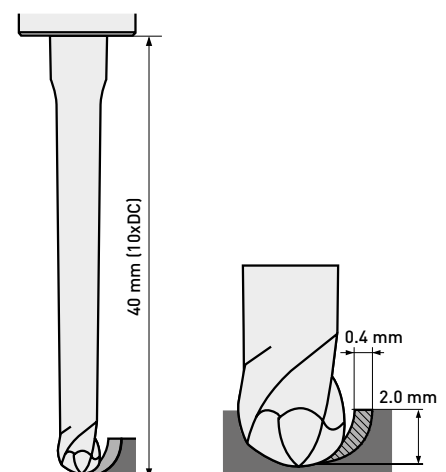

# ANWENDUNGSBEISPIELE

## VERGLEICH DER VORSCHUBGESCHWINDIGKEIT

Bis zu zweifache Vorschubgeschwindigkeit im Vergleich zu herkömmlichen Schafffräsern.

Werkstoff	1.4301
Werkzeug	MPMHVD1000
n (min <sup>-1</sup> )	2.300
Vc (m/min)	72.3
Vf (mm/min)	- 1.104
fz (mm/Zahn)	- 0.12
ap (mm)	10
ae (mm)	10
Auskragung (mm)	4 x DC
Schnittmodus	Gleichlauf
Kühlung	Emulsion
Maschine	Vertikal M/C (BT50)

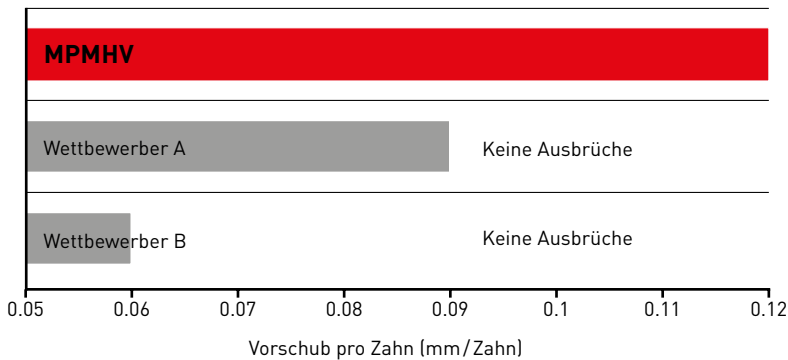
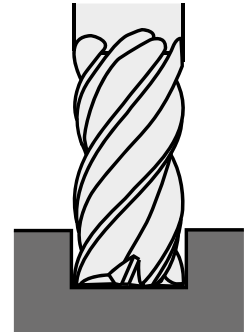

## VIBRATIONSFESTIGKEIT

Hervorragende Vibrationskontrolltechnologie.

Werkstoff	1.4301
Werkzeug	MPMHVD1000
n (min <sup>-1</sup> )	variabel
Vc (m/min)	variabel
Vf (mm/min)	640-2.240
fz (mm/Zahn)	0.1
ap (mm)	20
ae (mm)	siehe Tabelle
Auskragung (mm)	20
Schnittmodus	Gleichlauf
Kühlung	Emulsion
Maschine	Horizontal M/C (BT40)

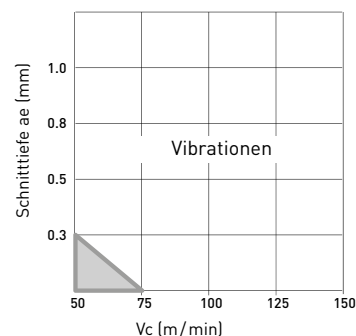
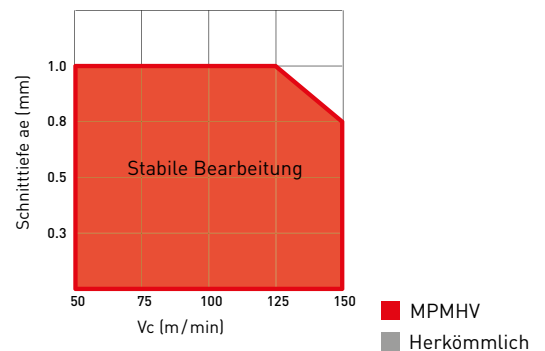

# ANWENDUNGSBEISPIELE

## VERGLEICH DER OBERFLÄCHENGÜTE

Durch variablen Spiralwinkel, reproduzierbar gute Oberflächengüte.

Werkstoff	1.4301
Werkzeug	MPJHVD0100AP04
n (min <sup>-1</sup> )	15.900
Vc (m/min)	50
Vf (mm/min)	357
fz (mm/Zahn)	0.004
ap (mm)	3.2
ae (mm)	0.003
Auskrägung (mm)	13
Schnittmodus	Gleichlauf
Kühlung	Emulsion
Maschine	Vertikal M/C

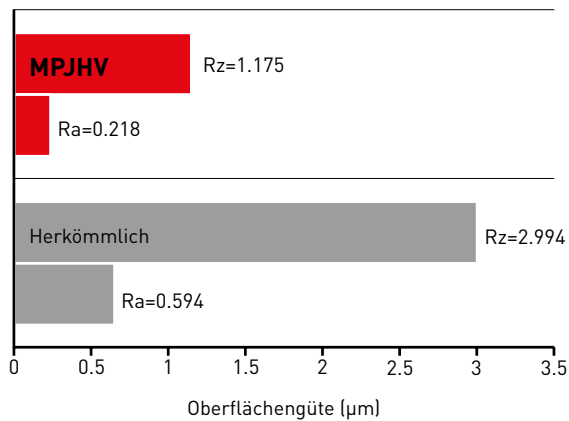
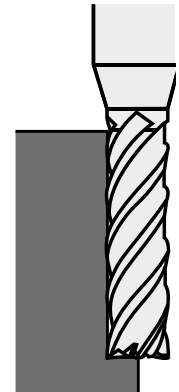

Bearbeitete Oberfläche Foto Rz

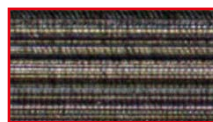

MPJHV

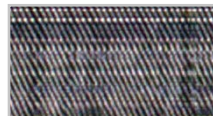

Herkömmlich

## X5CRN18-10 VIBRATIONSVERGLEICH

Werkstoff	1.4301
Werkzeug	MPMHVRBD1000R100
n (min <sup>-1</sup> )	Tabelle
Vc (m/min)	Tabelle
Vf (mm/min)	960 - 1600
fz (mm/Zahn)	0.1
ap (mm)	20
ae (mm)	0.8
Auskrägung (mm)	—
Schnittmodus	—
Kühlung	Emulsion
Maschine	Vertikales Bearbeitungszentrum (BT40)

n (min <sup>-1</sup> )	2400	3200	4000
Vc (m/min)	75	100	125

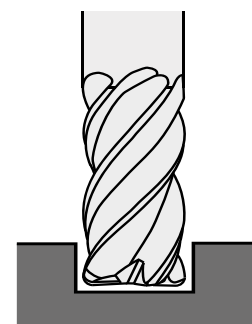
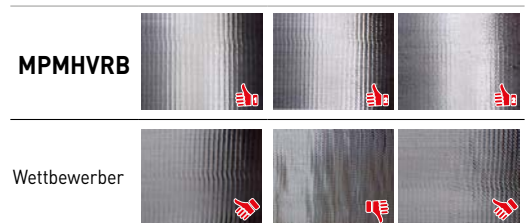



**GERMANY**

MMC HARTMETALL GMBH  
Comeniusstr. 2 . 40670 Meerbusch  
Phone +49 2159 91890 . Fax +49 2159 918966  
Email admin@mmchg.de

**U.K.**

MMC HARDMETAL U.K. LTD.  
Mitsubishi House . Galena Close . Tamworth . Staffs. B77 4AS  
Phone +44 1827 312312  
Email sales@mitsubishicarbide.co.uk

**SPAIN**

MITSUBISHI MATERIALS ESPAÑA, S.A.  
Calle Emperador 2 . 46136 Museros/Valencia  
Phone +34 96 1441711 . Fax +34 96 1443786  
Email comercial@mmevalencia.es

**FRANCE**

MMC METAL FRANCE S.A.R.L.  
6, Rue Jacques Monod . 91400 Orsay  
Phone +33 1 69 35 53 53 . Fax +33 1 69 35 53 50  
Email mmfsales@mmc-metal-france.fr

**POLAND**

MMC HARDMETAL POLAND SP. Z O.O  
Al. Armii Krajowej 61 . 50-541 Wrocław  
Phone +48 71335 1620 . Fax +48 71335 1621  
Email sales@mitsubishicarbide.com.pl

**ITALY**

MMC ITALIA S.R.L.  
Viale Certosa 144 . 20156 Milano  
Phone +39 0293 77031 . Fax +39 0293 589093  
Email info@mmc-italia.it

**TURKEY**

MMC HARTMETALL GMBH ALMANYA - İZMİR MERKEZ ŞUBESİ  
Adalet Mahallesi Anadolu Caddesi No: 41-1 . 15001 35530 Bayraklı /İzmir  
Phone +90 232 5015000 . Fax +90 232 5015007  
Email info@mmchg.com.tr

**[www.mitsubishicarbide.com](http://www.mitsubishicarbide.com) | [www.mmc-hardmetal.com](http://www.mmc-hardmetal.com)**

VERTRIEB DURCH:

┌

┐

└

┘